



Acteon® Sopro® Intraoral Cameras on A-dec 532/533/541 Delivery Systems

INSTALLATION GUIDE

Contents

Before You Begin	2
532B/533B: Install the Handpiece Tubing and Mini Dock	2
541B: Install the Handpiece Tubing and Mini Dock	18
Connect the Mini Dock to the Powered USB Hub	27
Install the Camera Software on the PC	30
Test the Installation	31
Reinstall the Covers	33
Appendix A: 532B/533B - Change an Active Holder Position to an Inactive Holder Position	36
Appendix B: 532B/533B - Change an Inactive Holder Position to an Active Holder Position	37
Regulatory Information and Warranty	40



Product Models and Versions Covered in This Document

Models	Versions	Description
532/533/541	B	Delivery System

Before You Begin



IMPORTANT You must first install the A-dec Powered USB Hub before installing a camera on the delivery system. See the instructions that ship with the powered USB hub to install the hub.



NOTE Information that is critical to a successful installation is shaded like this note throughout the guide.



CAUTION When removing or replacing covers, take care not to damage any wiring or tubing. Verify that the covers are secure after replacing them.



ATTENTION Circuit boards are sensitive to static electricity. Electrostatic Discharge (ESD) precautions are required when touching a circuit board or making connections to or from the circuit board. Circuit boards should be installed only by an electrician or qualified service person.

Recommended Tools

- Anti-static wrist strap
- Standard and Phillips head screwdrivers
- Diagonal cutters
- Sleeve pusher
- Pliers
- Wire strippers

532B/533B: Install the Handpiece Tubing and Mini Dock

Prepare the Chair and Delivery System

- 1** Turn on the power to the system using the master toggle.
- 2** Fully raise the chair base and back.



WARNING Failure to turn off or disconnect the power before you begin this procedure can lead to product damage and result in serious injury or death.

- 3** Turn off the power to the system using the master toggle.

Install the Handpiece Tubing

532B: Install the Handpiece Tubing3
533B: Install the Handpiece Tubing7

The camera can be installed in any holder position. If it is installed in an active position, the touchpad displays **Camera** when the camera is lifted from the holder position. If the doctor wants the camera placed in an active position (usually positions 2-5), but wants four active positions for other handpieces, you will need to change the holdback air tubing connections for the selected active position and one of the inactive positions. To change an active holder position to an inactive holder position, see “Appendix A: 532B/533B - Change an Active Holder Position to an Inactive Holder Position” on page 36.

Alternatively, if the doctor wants the camera installed in an inactive position, but wants the touchpad to display **Camera** when the camera is lifted from the holder, you will need to change the inactive holder position holdback air tubing connections. To change an inactive holder position to an active holder position, see “Appendix B: 532B/533B - Change an Inactive Holder Position to an Active Holder Position” on page 37.

532B: Install the Handpiece Tubing

- 1 Swivel the touchpad to the side.

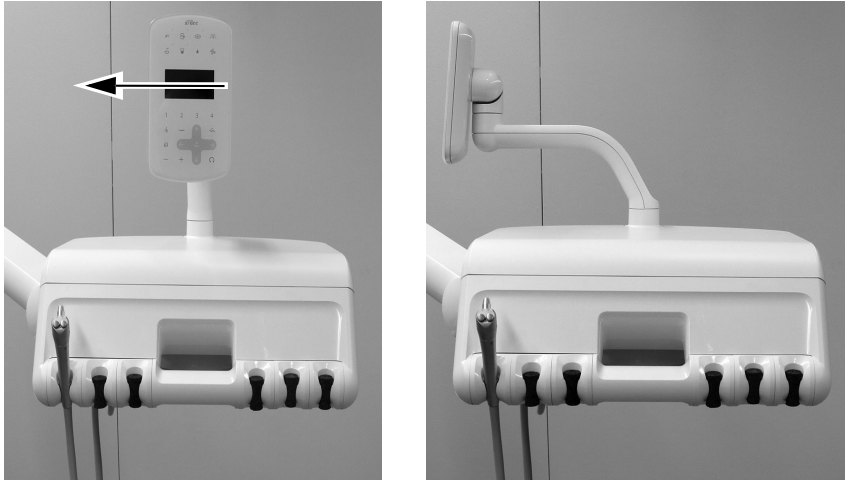

- 2 Push up on the cover release at the back of the control head and lift the top cover off the control head.



3 Pull the front cover off the control head.

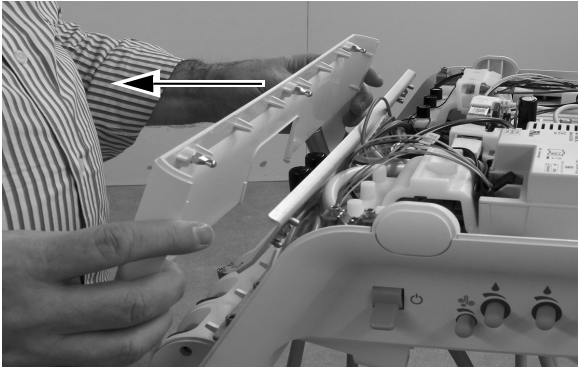

4 Position the camera tubing above the opening in the control head behind the holder position where you want to install the camera.

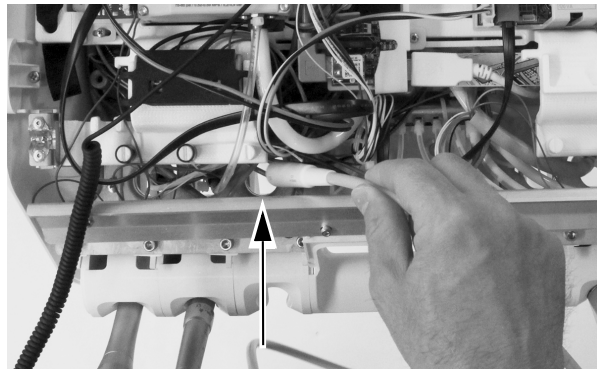

CAUTION Do not remove the aluminum plate on the front of the delivery system. The screws that secure the plate screw into plastic, not metal. Repeated removal of the screws over time will deform the plastic and loosen the front cover of the delivery system.

5 Route the camera tubing down through the opening in the control head behind the holder position where you want to install the camera.

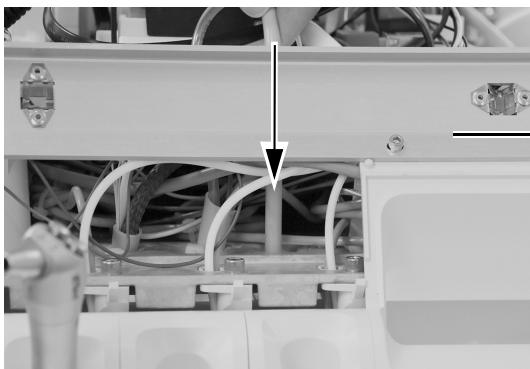

Do not remove the aluminum plate.

- 6** Set the handpiece tubing nut into the desired holder position.

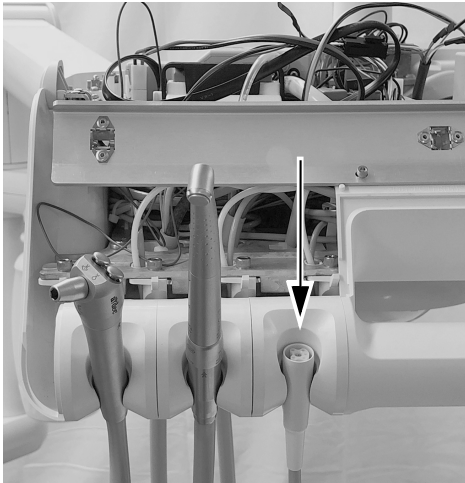

- 7** Adjust the drape of the tubing to match the drape of the other tubing on the control head and mark the tubing sheath about 1/2" above the chassis.



- 8** **Optional:** Remove the end of the tubing from the control head. Cut the tubing sheath back to the mark and cut off the sheath.



- 9** Insert the tubing up through the chassis. Place a cable tie around the tubing about 1/2" (12 mm) below the mark on the tubing. Do not tighten the cable tie until instructed. Leave a large loop as shown.

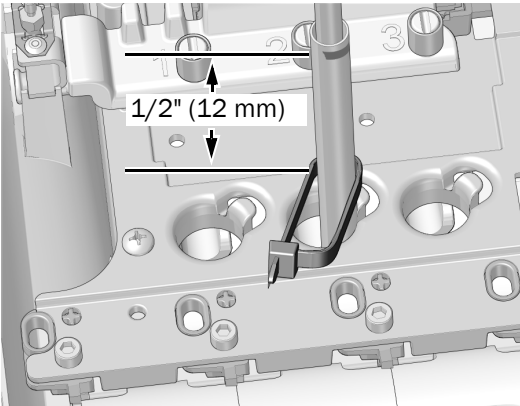

NOTE The aluminum panel is not shown to enhance visibility.

- 10** Position the cable tie loop around the post at the edge of the tubing hole in the chassis. Be sure the loop in the cable tie is behind the post.

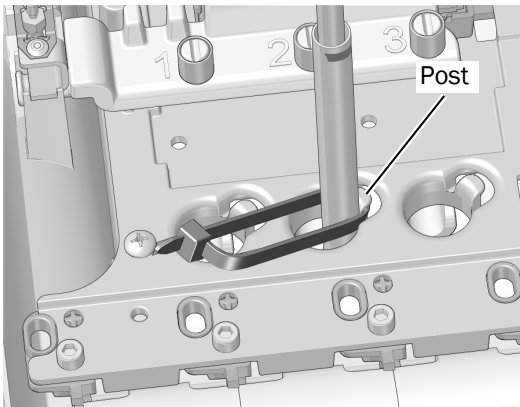

- 11** Push the cable tie down so it is below the top of the post. Tighten the cable tie to ensure it remains around the post. Cut off the excess cable tie.

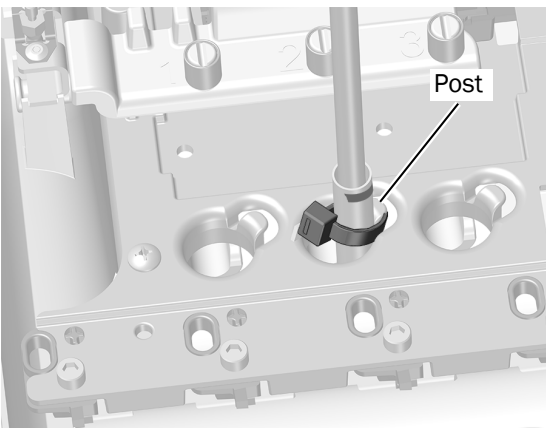

Next Step Proceed to "Plumb the Air/Electric Switches" on page 10.

533B: Install the Handpiece Tubing

- 1 Lift the corner of the instrument pad on the side of the delivery system on which you are going to install the camera.

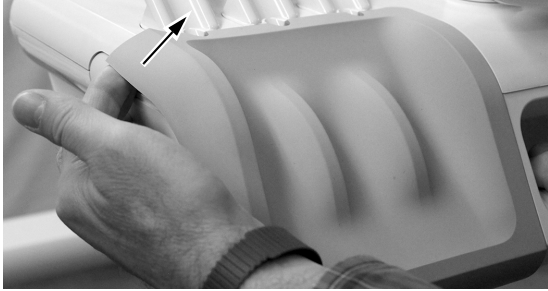

- 2 Carefully pull the instrument pad away from the control head.

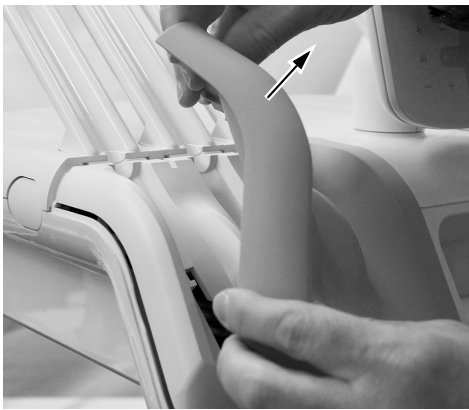

- 3 Rotate the side of the tubing guide forward.

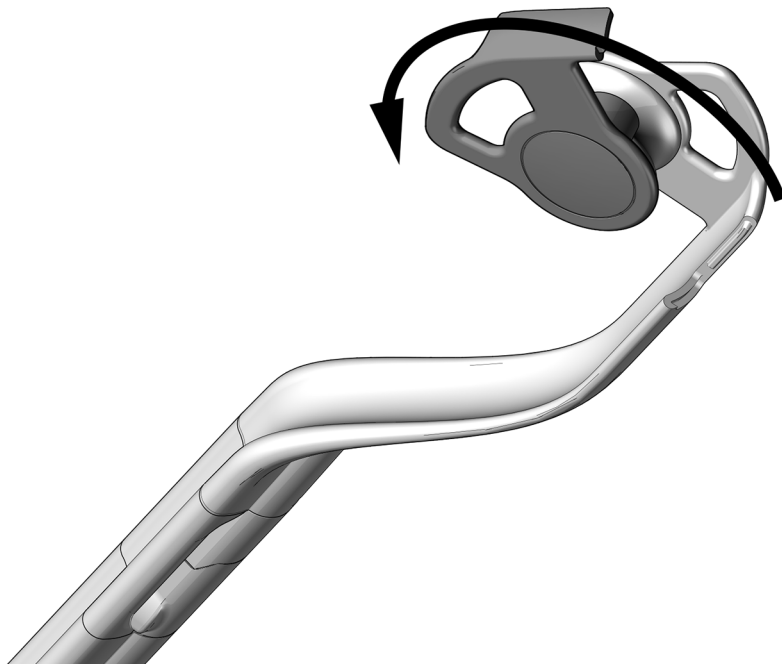

- 4** Route the tubing through the whip assemblies.
- 5** Close the tubing guide and make sure it snaps shut.

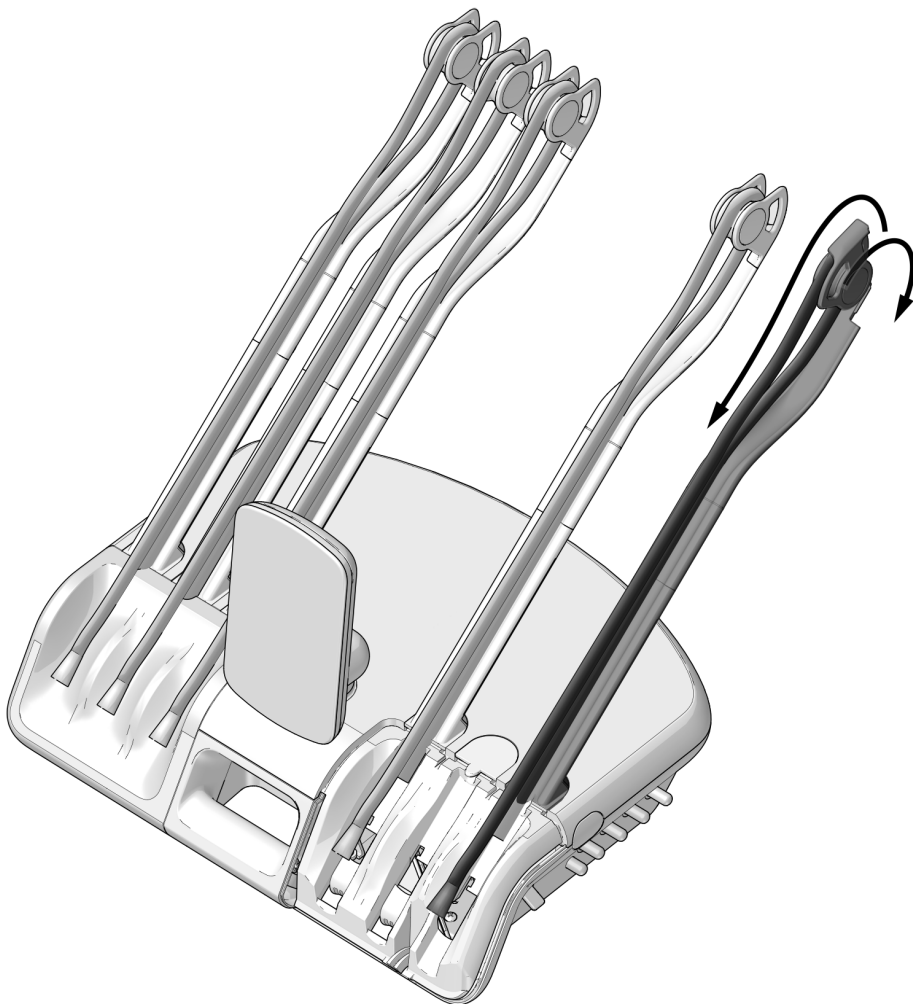

- 6** Place the handpiece and tubing onto the control head, adjusting the position of the handpiece tubing nut as shown.



- 7** Loop a cable tie around the tubing and move the cable tie up so it loops around the tab at the top of the opening.



- 8** Tighten the cable tie around the tubing so it is snug. Cut off the excess cable tie.

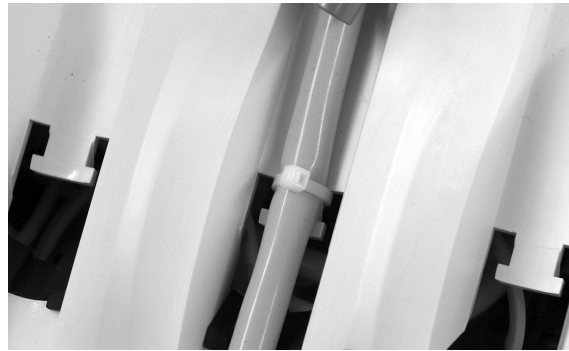

CAUTION To avoid damaging the syringe or other installed handpieces, be careful to lay each handpiece tubing behind the whips on the opposite side of the control head before you lift the top of the control head.

- 9** Push up on the cover release at the back of the control head and lift the top cover up from the control head and rotate the cover all the way forward.

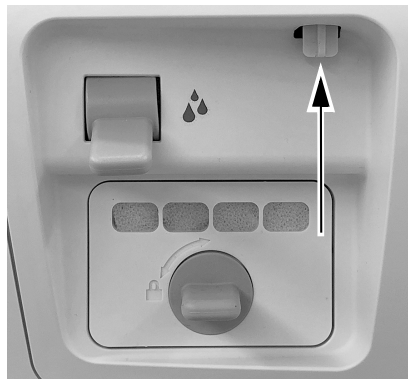
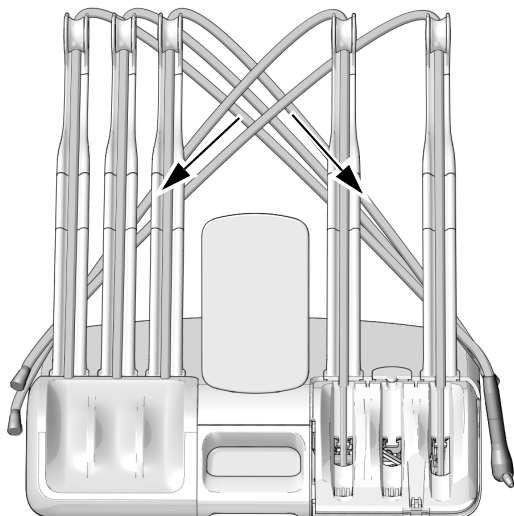

Plumb the Air/Electric Switches



ATTENTION Circuit boards are sensitive to static electricity. Electrostatic Discharge (ESD) precautions are required when touching a circuit board or making connections to or from the circuit board. Circuit boards should be installed only by an electrician or qualified service person.

Plumb the Air-Electric Switches for an Inactive Holder Position10
Plumb the Air-Electric Switches for an Active Holder Position12

Plumb the Air-Electric Switches for an Inactive Holder Position

- 1 Place a grounding strap on one wrist and connect the other end of the grounding strap to the grounding lug mounted on the flush toggle at the back of the control head.



- 2 Locate the gray holdback air tubing for the desired inactive holder.

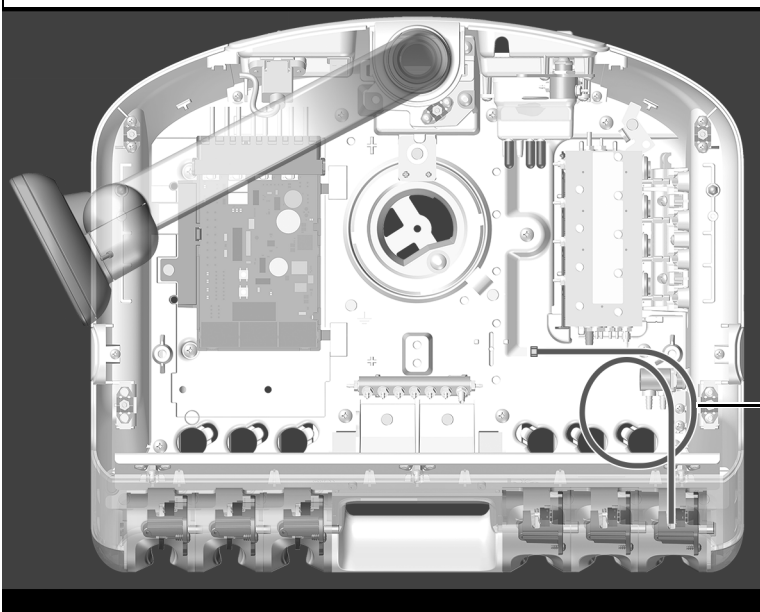

NOTE The module shelf is not shown to enhance visibility.

- 3 Remove the plug at the end of the holdback air tubing.
- 4 Connect the gray tubing from the normally closed air-electric switch to the gray holdback air tubing with an inline barb.

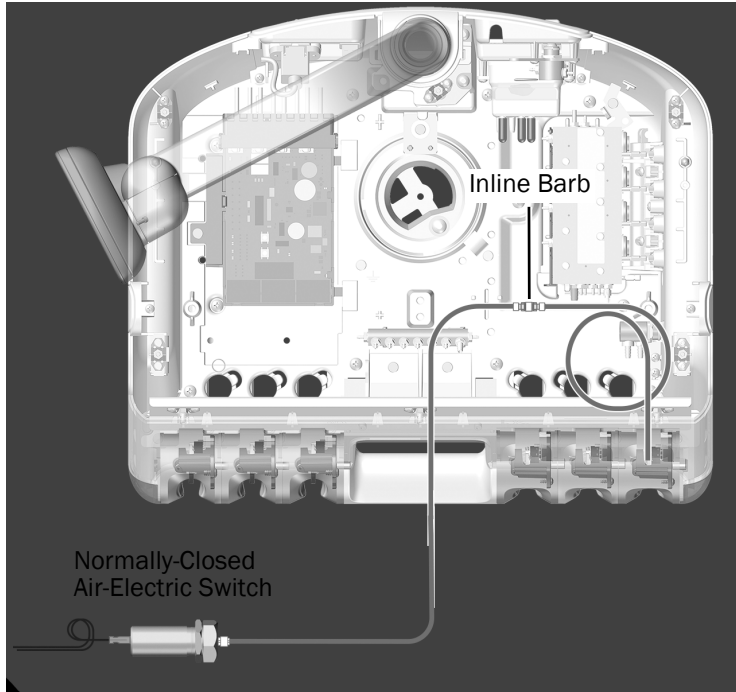

NOTE When installing inline connections, be certain to use the sleeve clamps included in the kit. They must be installed and pressed tight to ensure a solid connection.

- 5 Connect the orange tubing from the normally-open air-electric switch to the drive-air barb on the end of the control block. Secure the tubing on the barb with a tubing clamp.

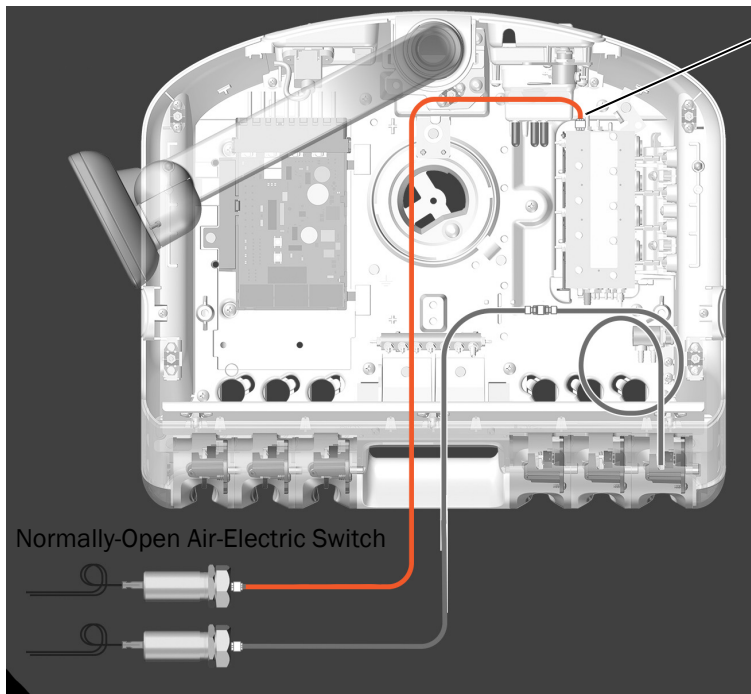

Drive-Air Barb on Control Block

Plumb the Air-Electric Switches for an Active Holder Position

- 1 Place an anti-static wrist strap snugly on one wrist and connect the other end of the wrist strap to the grounding lug mounted on the flush toggle at the back of the control head.



- 2 Locate the holdback air tubing for the active holder position.

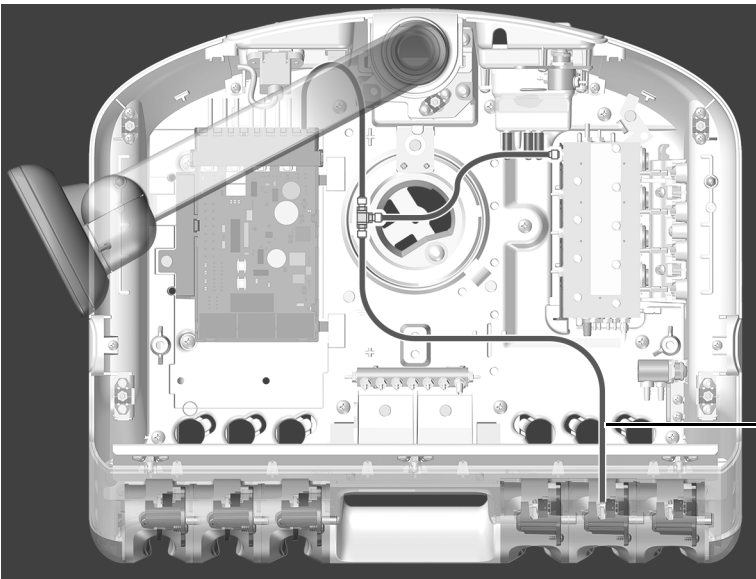

NOTE The module shelf is not shown to enhance visibility.

Gray Holdback Air Tubing

- 3** Insert a T-connector into the holdback air tubing from the selected active holder. Connect the gray tubing from the normally closed air-electric switch to the T-connector in the holdback air tubing.

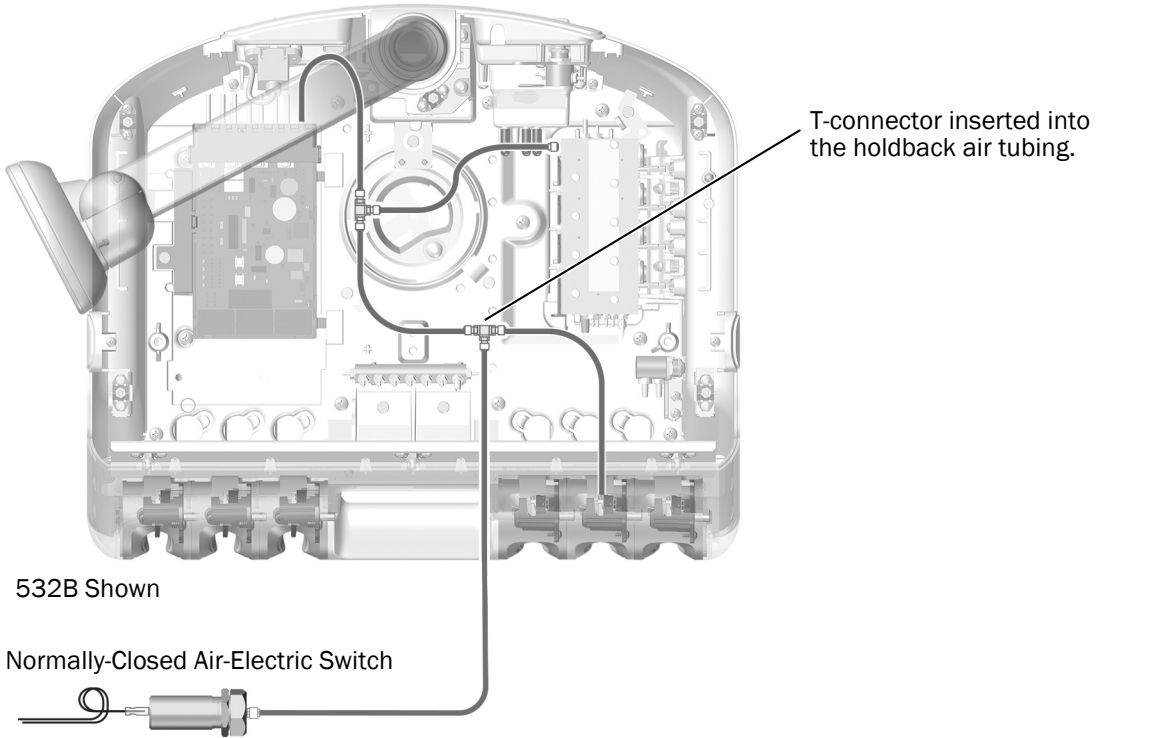

- 4** Connect the orange tubing from the normally-open air-electric switch to the drive-air barb on the end of the control block. Secure the tubing on the barb with a tubing clamp.

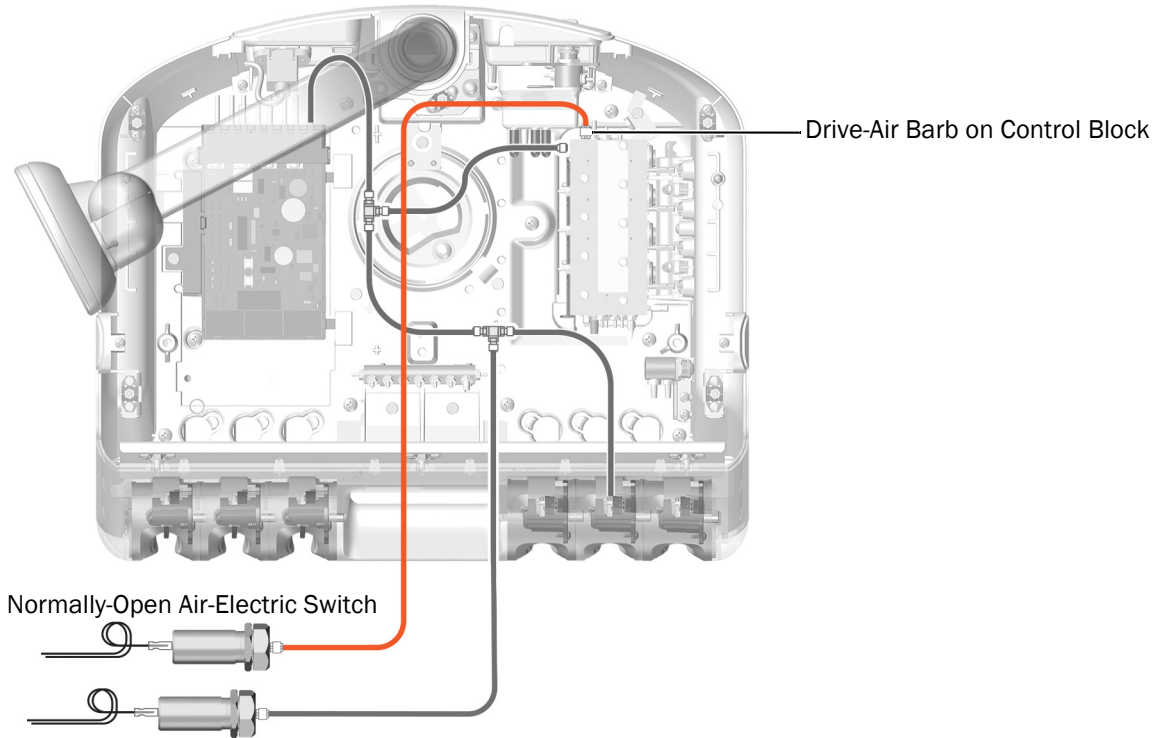

Install the Mini Dock on the Module Shelf

Wire the Air-Electric Switch to the Mini Dock	14
Secure the Mini Dock to the Module Shelf	16
Set the Freeze Image Mode	17

Wire the Air-Electric Switch to the Mini Dock

- 1 Place the two air-electric switches in the Mini Dock cover.

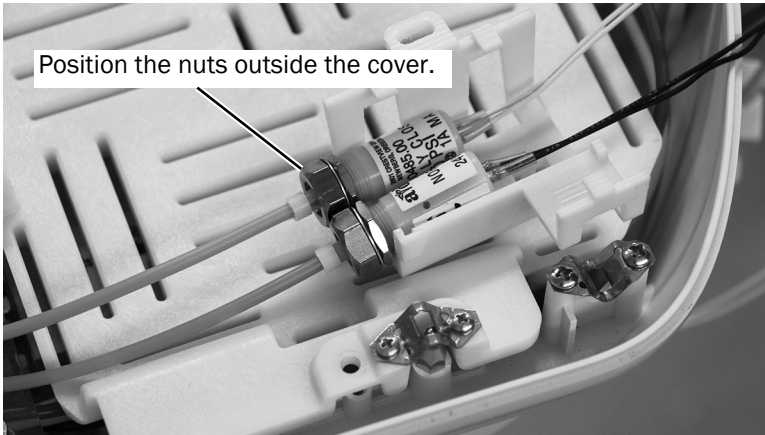

- 2 Slide the Mini Dock into the cover.

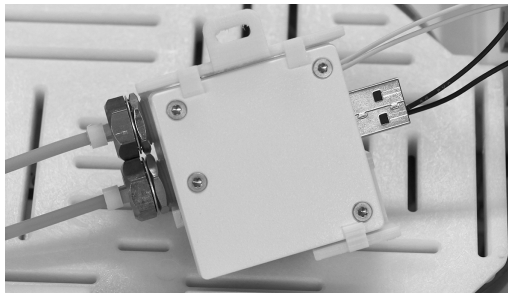
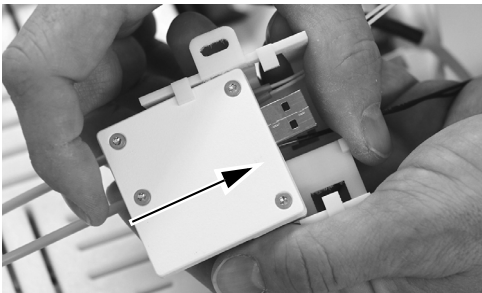

- 3 Coil the wires from the two air-electric switches together and insert the wires between the Mini Dock and the Mini Dock cover.
- 4 Insert the wires from the air-electric switches into the terminal strip connector on the Mini Dock as shown.

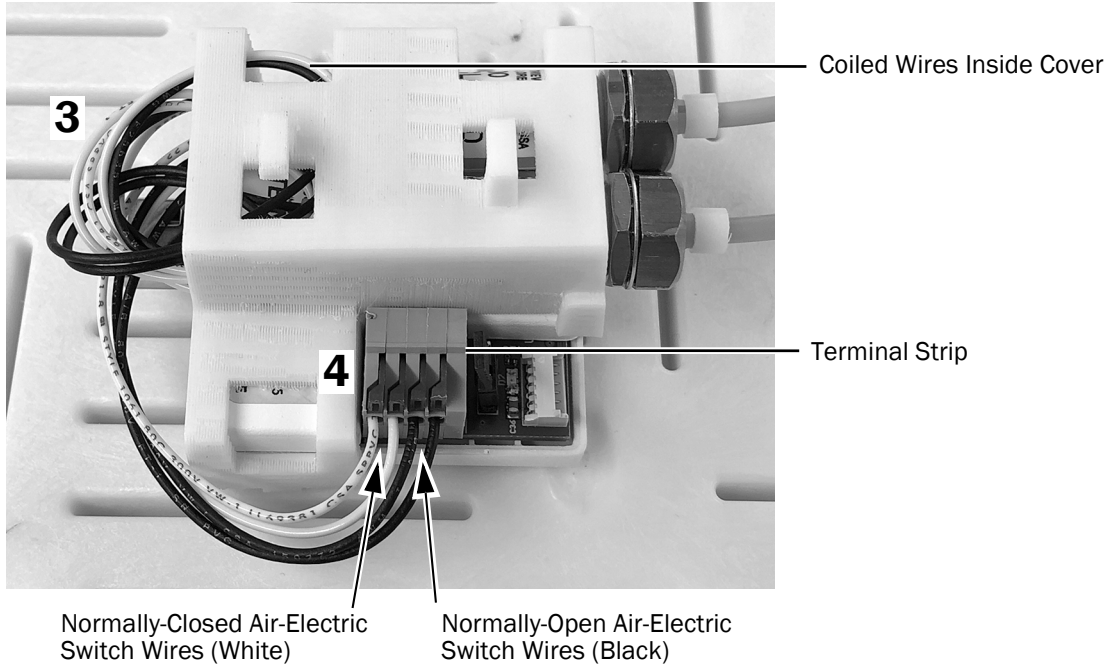

NOTE Use a small, flat screwdriver to press the lever of the spring terminal, then install the wire into the terminal and release the lever.

- 5 Orient the camera cable as shown below and insert it into the Mini Dock terminal strip.

Correct Side Up



Wrong Side Up



Correctly Inserted

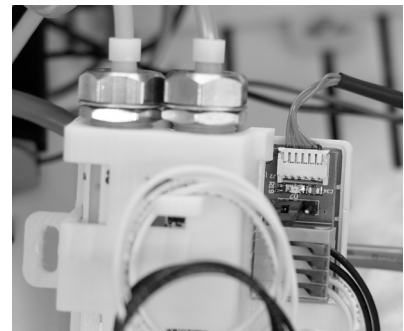

Secure the Mini Dock to the Module Shelf

- 1 To ensure maximum flexibility for future installations, note the recommended placement of the Mini Dock on the module shelf as shown below.

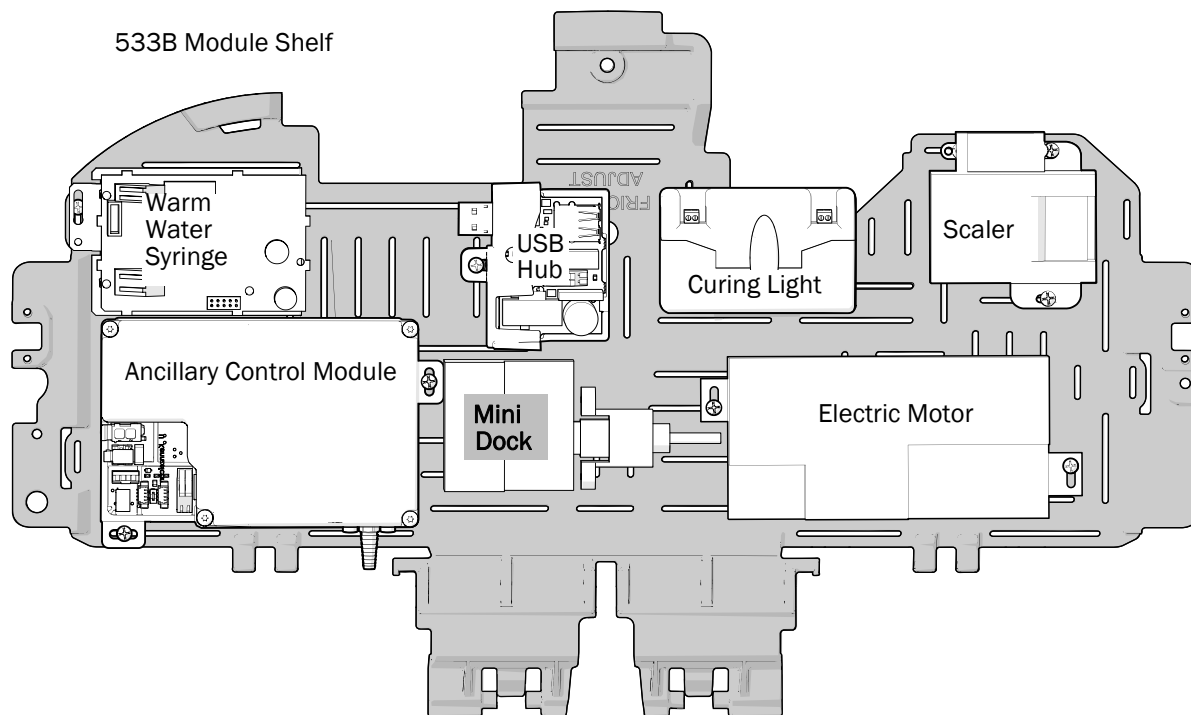
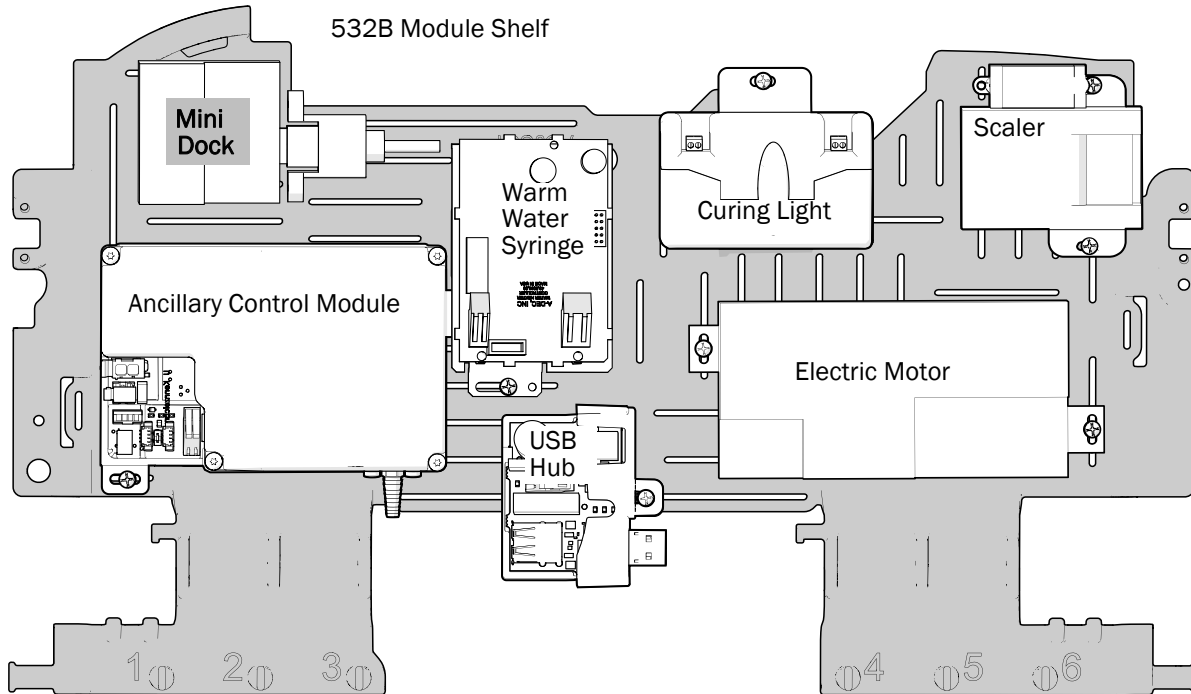

- 2 Position the Mini Dock on the module shelf and use a stainless steel screw to secure the Mini Dock to the module shelf.

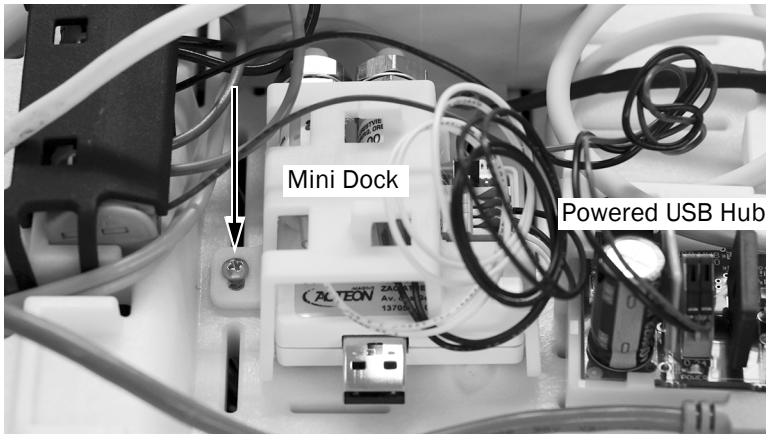

533B Shown

Set the Freeze Image Mode

You can freeze the image using either SoproTouch on the handpiece or the dental chair footswitch. You specify which method to use by setting a jumper on the Mini Dock.

- 1 Set the jumper position on the Mini Dock as desired by the doctor.

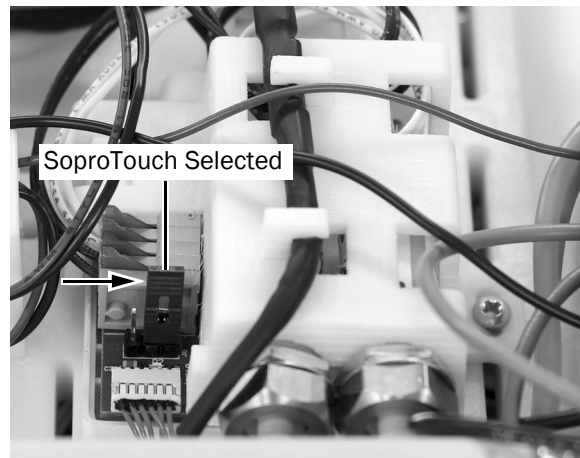

NOTE If the jumper position is changed after the system is turned on, you must turn off the system and turn it back on after you change the jumper position.

Next Step Continue with “Connect the Mini Dock to the Powered USB Hub” on page 27.

541B: Install the Handpiece Tubing and Mini Dock

Install the Handpiece Tubing18

Install the Mini Dock on the 12 O'Clock Frame Unit20

Install the Handpiece Tubing

- 1 Pull a cover out at the bottom and pull it away from the delivery system. Remove both side covers.



- 2 On the underside of the instrumentation arm, use a 5/32" hex key to remove the screw that secures the top cover on the instrumentation arm.

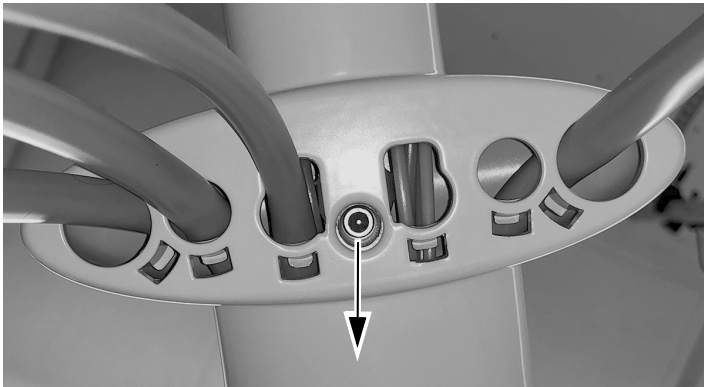

- 3 Slide the top cover away from the touchpad and remove the top cover.

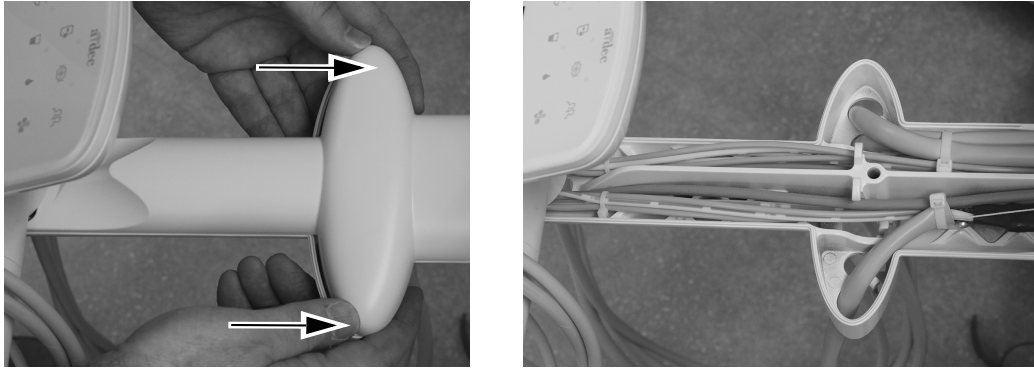

- 4 Route the camera tubing up through the instrumentation arm.

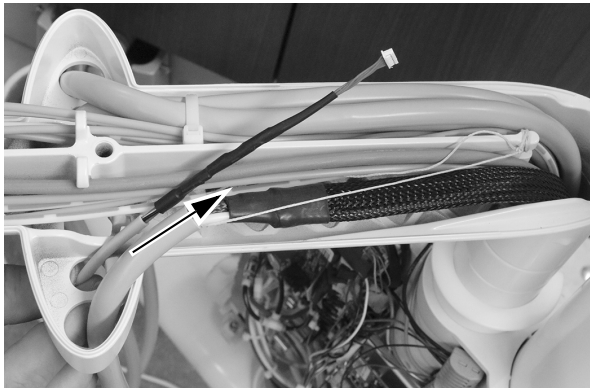

- 5 Route the camera tubing down through the post.

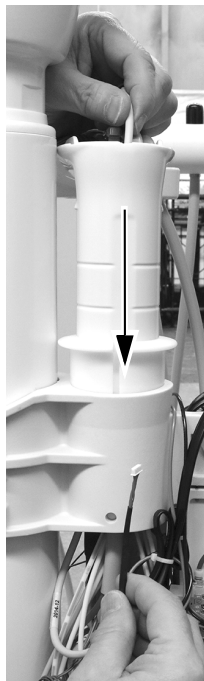

Install the Mini Dock on the 12 O'Clock Frame Unit



ATTENTION Circuit boards are sensitive to static electricity. Electrostatic Discharge (ESD) precautions are required when touching a circuit board or making connections to or from the circuit board. Circuit boards should be installed only by an electrician or qualified service person.

- 1 Place a anti-static wrist strap snugly on one wrist and connect the other end of the wrist strap to the grounding lug located near the edge of the delivery system circuit board.

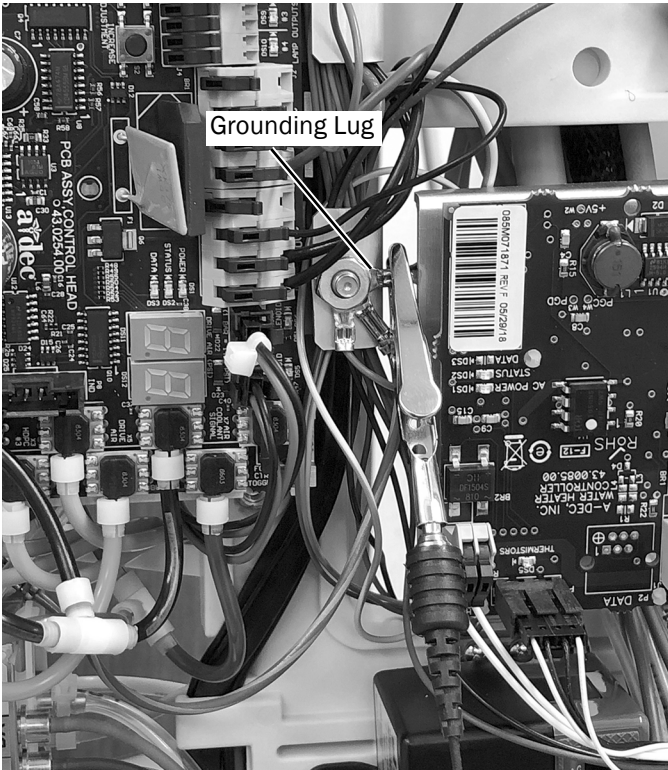

Plumb the Air-Electric Switches

- 1 Use a 5/32" hex wrench to remove the screw and washer that secure the control block to the 12 o'clock frame unit.

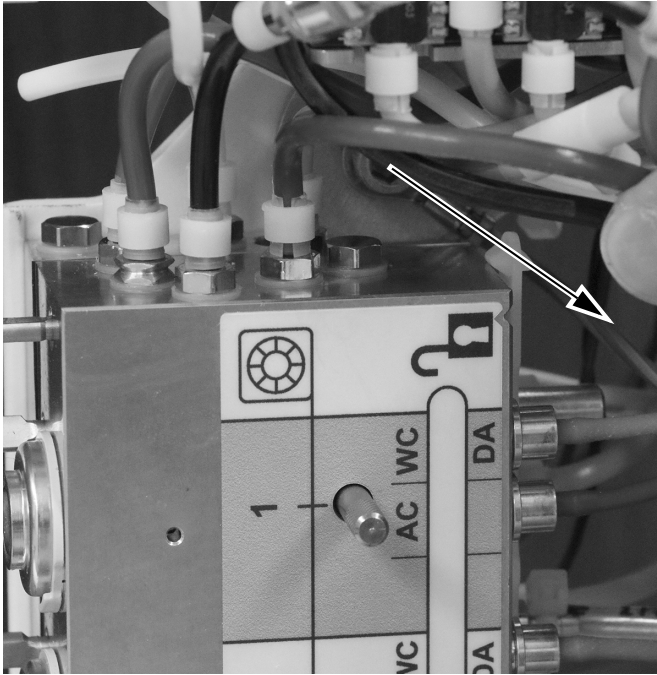

- 2 Remove the plug from the drive air port on the control block.

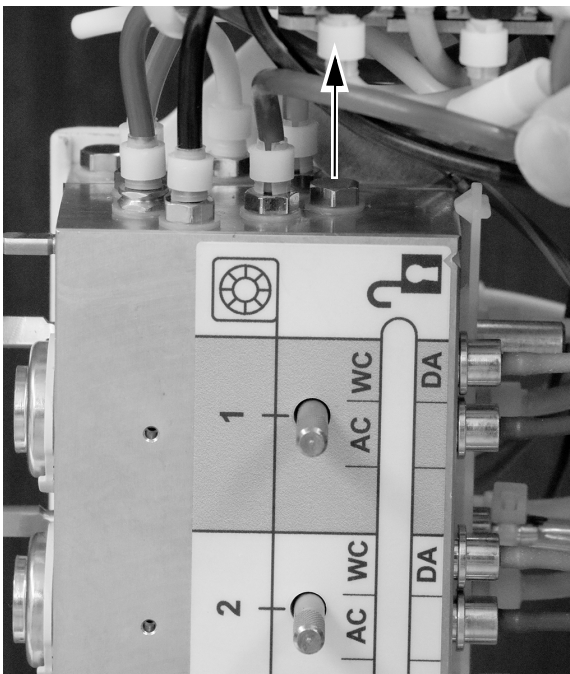

- 3 Install a barb into the drive-air port on the end of the control block.
- 4 Connect the orange tubing from the normally-open air-electric switch to the drive-air barb on the end of the control block. Secure the tubing on the barb with a tubing clamp.

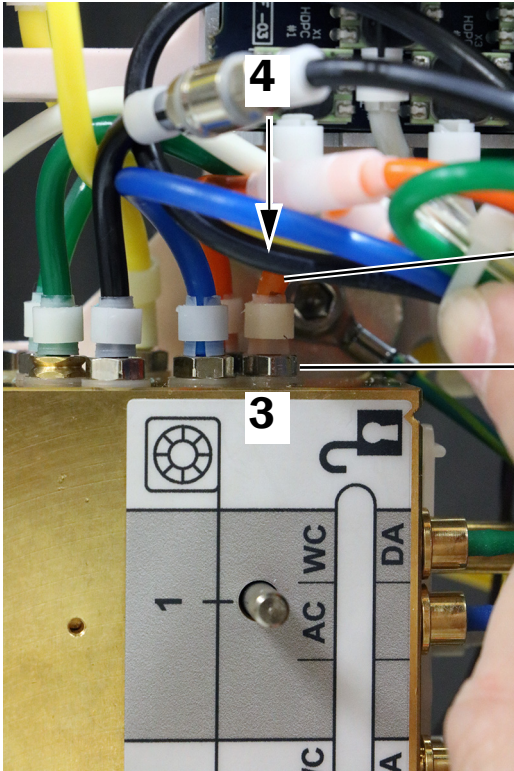

Orange Tubing from Air-Electric Switch

Barb in Drive Air Port



NOTE Be sure to use a new nylon washer between the barb and the control block when installing the barb.

Wire the Air-Electric Switch to the Mini Dock

- 1 Place the two air-electric switches in the Mini Dock cover.

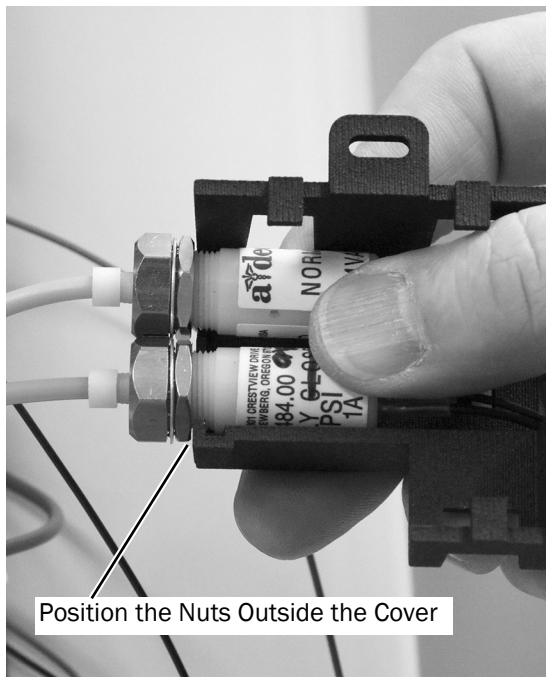

- 2 Slide the Mini Dock into the cover.

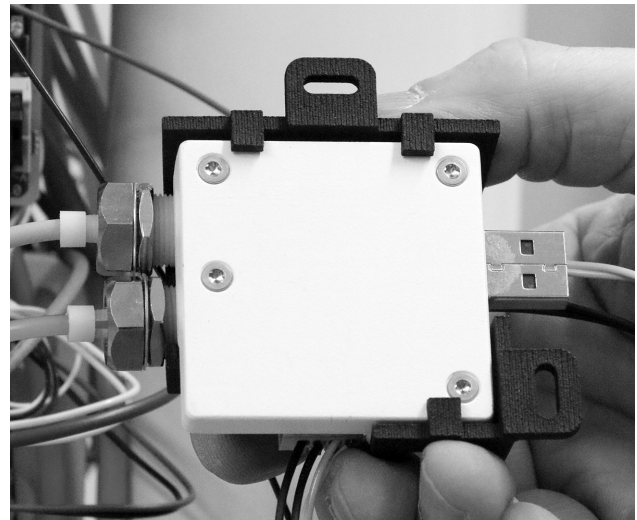
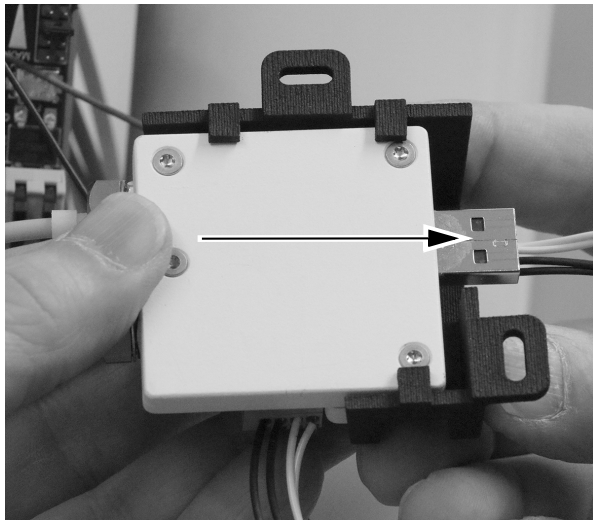

- 3 Coil the wires from the two air-electric switches together and insert the wires between the Mini Dock and the Mini Dock cover.
- 4 Insert the wires from the air-electric switches into the terminal strip connector on the Mini Dock as shown.

Push the lever back to insert the wire.

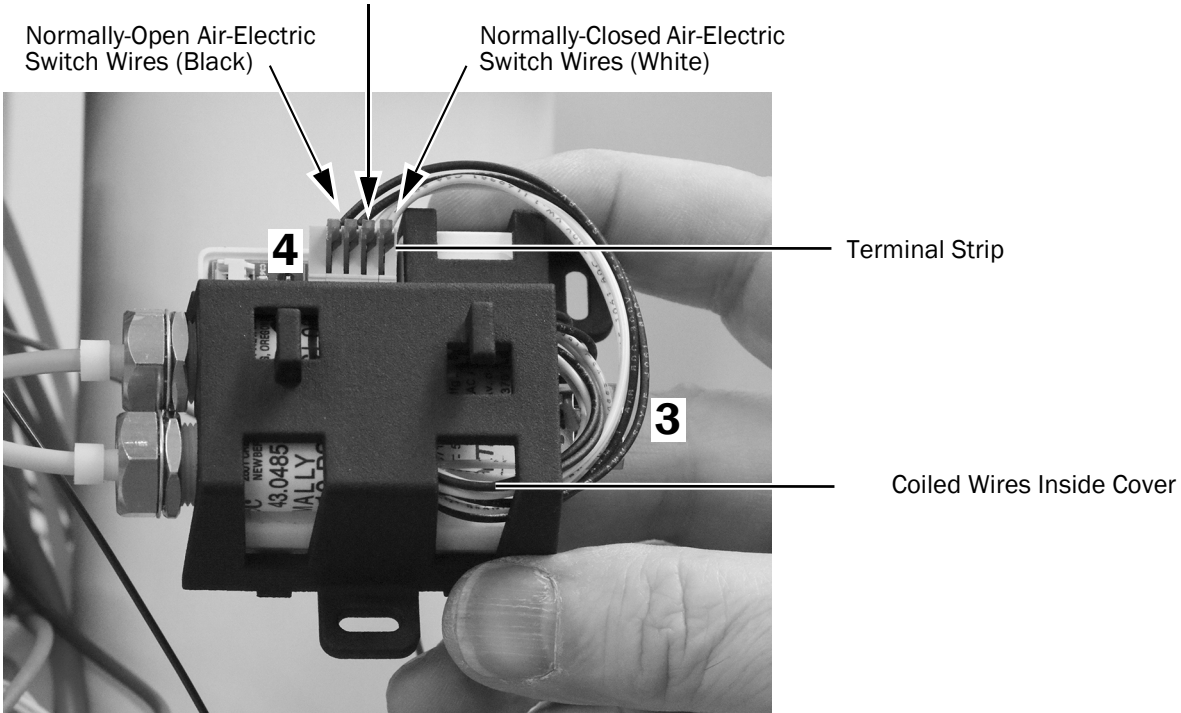

NOTE Use a small, flat screwdriver to press the lever of the spring terminal, then install the wire into the terminal and release the lever.

- 5 Orient the camera cable as shown below and insert it into the Mini Dock terminal strip.

Correct Side Up

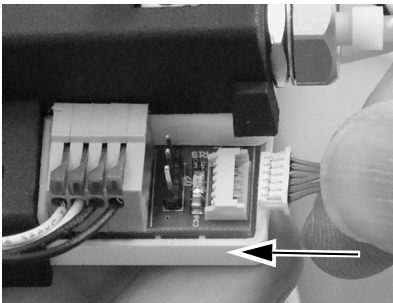

Wrong Side Up

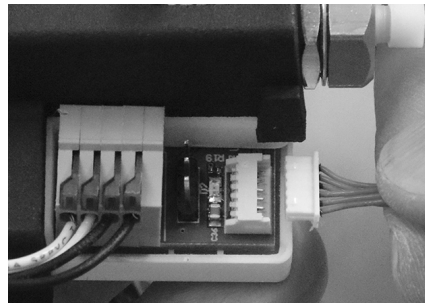

Correctly Inserted

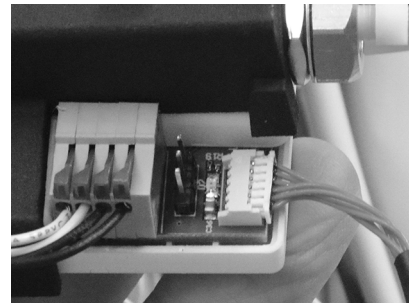

Secure the Mini Dock to the Module Shelf

- 1 To ensure maximum flexibility for future installations, note the recommended placement of the Mini Dock as shown below.

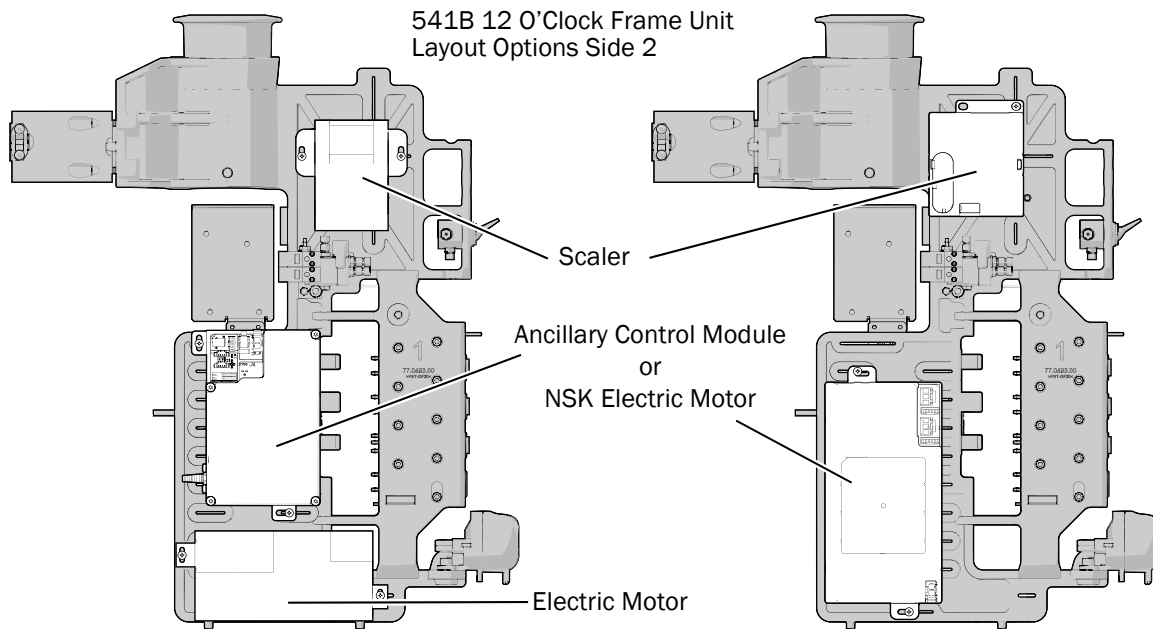
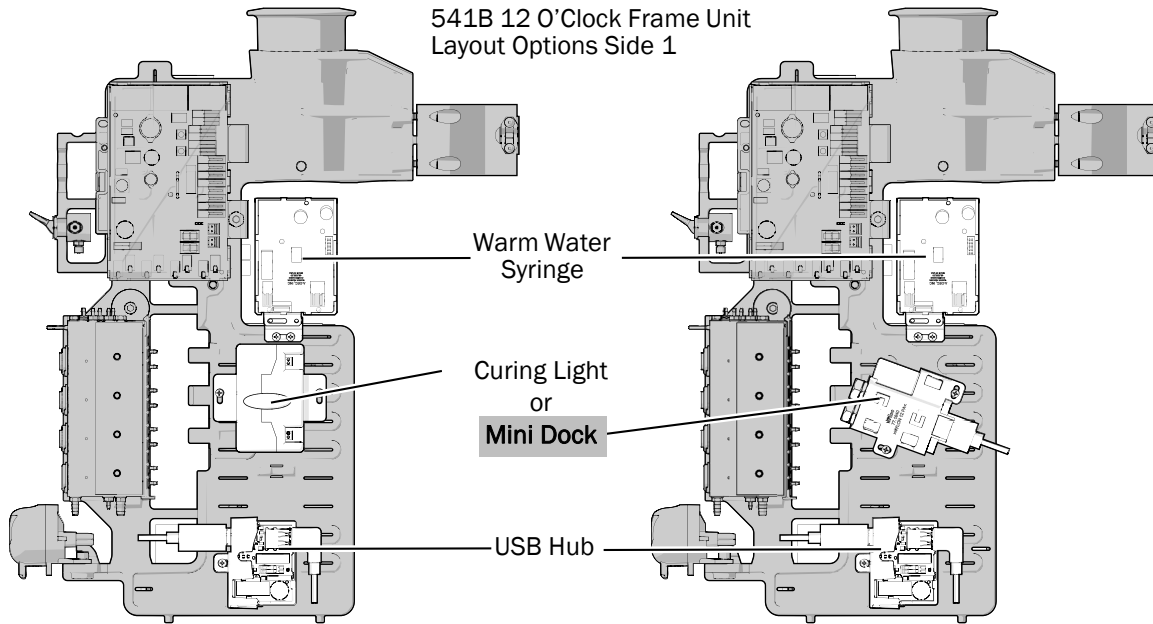

- 2 Position the Mini Dock on the 12 o'clock frame unit and use two stainless steel screws to secure the Mini Dock.

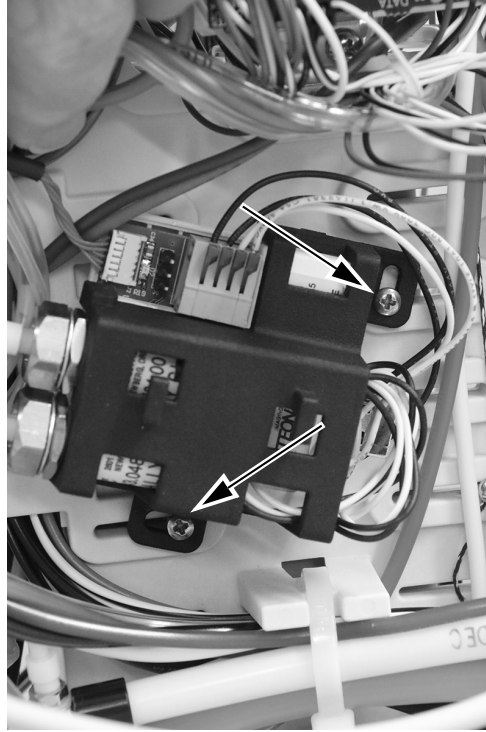
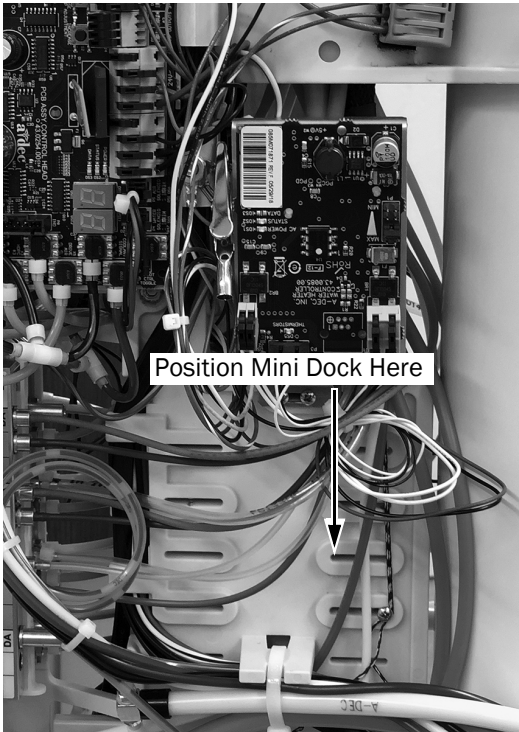

Set the Freeze Image Mode

You can freeze the image using either SoproTouch on the handpiece or the dental chair footswitch. You specify which method to use by setting a jumper on the Mini Dock.

- 1 Set the jumper position on the Mini Dock as desired by the doctor.

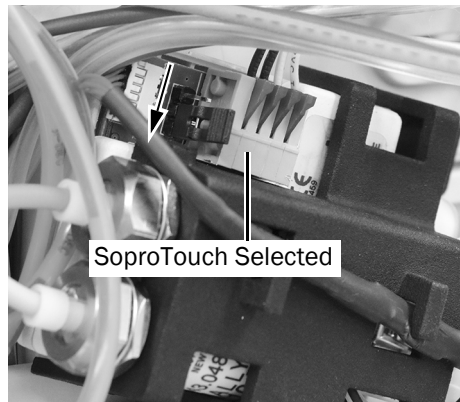
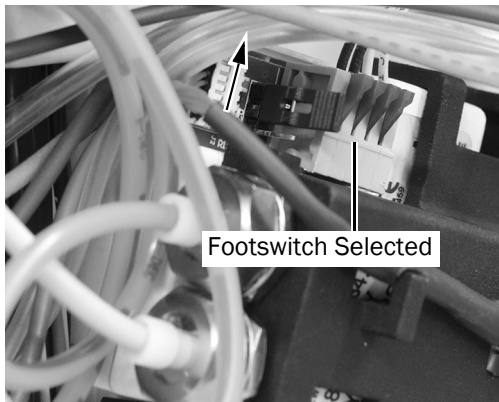

NOTE If the jumper position is changed after the system is turned on, you must turn off the system and turn it back on after you change the jumper position.

Connect the Mini Dock to the Powered USB Hub

- 1 Connect the USB cable between the Mini Dock and the powered USB hub.
- 2 Position the camera cable under the hooks on the top of the Mini Dock cover.

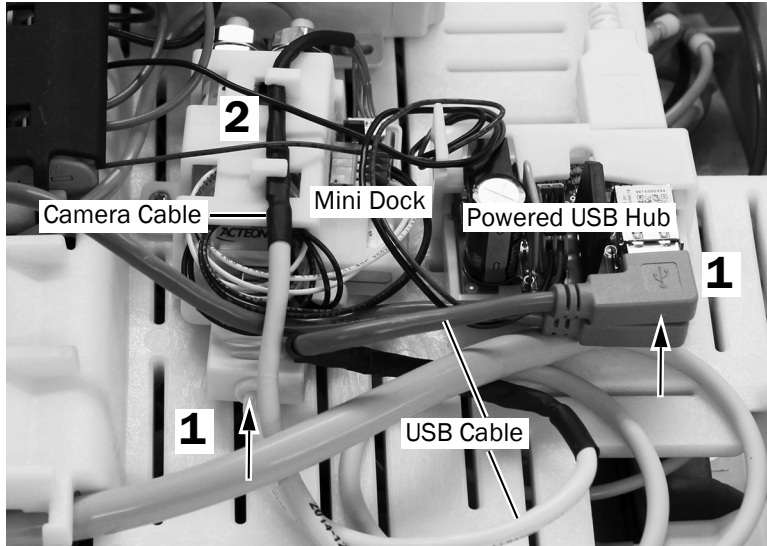

533B Shown

Connect the Delivery System USB Cable to a PC

- 1 Locate the delivery system USB cable in the dental chair floorbox or inside the cabinet.
- 2 Connect the USB cable to the supplied USB active repeater cable.

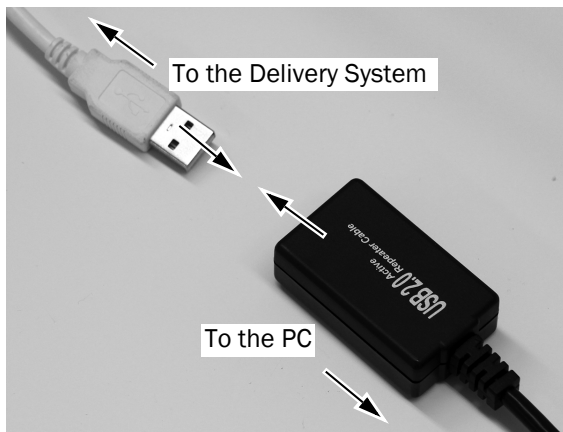

- 3 Route the USB active repeater cable to the PC.



NOTE You may use an additional USB active repeater cable to connect to a PC depending on the length of the cable between the floorbox and the PC.

4 Connect the USB repeater cable to the PC.



CAUTION If you have already connected the camera to the tubing, disconnect the camera from the tubing before you connect the USB cable to the PC.

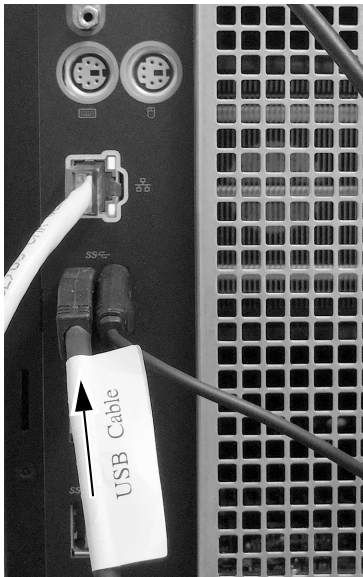

- Next Step** **532B Only:** Continue with “Configure the Handpiece Settings” on page 30.
533B Only: Continue with “533B: Close the Cover” on page 29.
541B Only: Continue with “Configure the Handpiece Settings” on page 30.

533B: Close the Cover



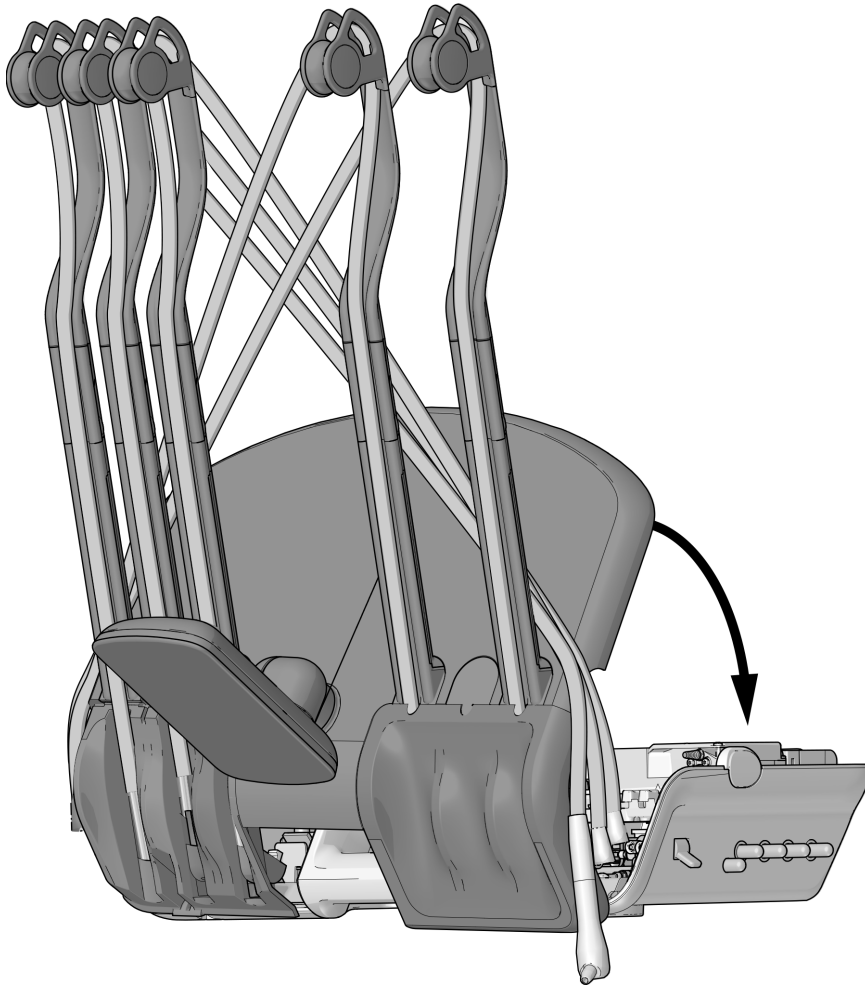

CAUTION When removing or replacing covers, take care not to damage any wiring or tubing. Verify that the covers are secure after replacing them.

- 1** Lower the top cover. Be careful not to kink or pinch any tubing. Squeeze the back of the cover and the control head together to ensure the cover is fully seated on the control head.



- 2** Replace the handpiece tubing in their normal position on the whips.

Configure the Handpiece Settings

- 1** Turn on the system with the master toggle.
- 2** Press and hold  and  at the same time until a **System Setup** screen appears.
- 3** Press \rightarrow .
- 4** Press \rightarrow again to select **Handpieces**.
- 5** Press \rightarrow on the **Handpiece Setup** screen to select **Holder Setup**.
- 6** Lift the handpiece from the holder.
- 7** Press $-$ or $+$ to change the highlighted choice to **Camera** and press \rightarrow to select it.
- 8** Return the handpiece to the holder.
- 9** Press \leftarrow until you see the A-dec logo.

Install the Camera Software on the PC

Follow the instructions in the Sopro Quick Start, which ships with the camera, to install the camera viewing software on the PC.

Test the Installation

- 1 Turn on the system using the master toggle.

Preliminary Test

- 1 If you haven't installed the camera yet, install it on the camera tubing.

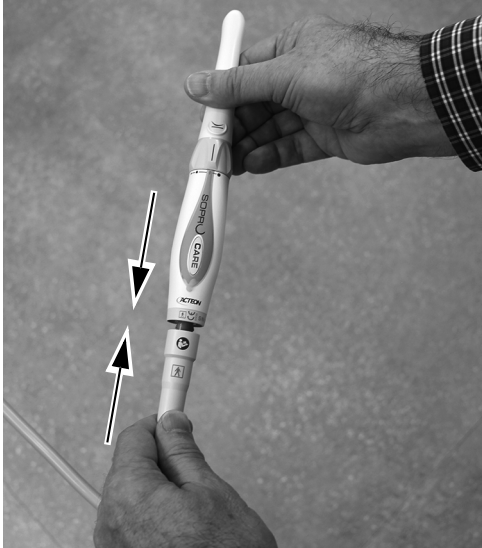

- 2 Put a barrier on the camera handpiece.

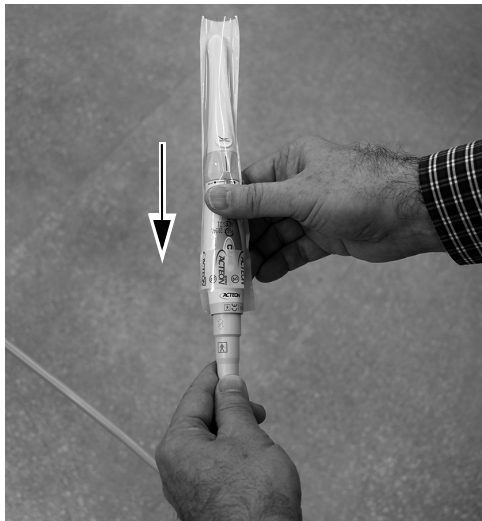

- 3 Verify the PC is turned on.

- 4 Verify that four green LEDs on the powered USB hub are illuminated. If the LEDs are not illuminated, check the power and USB cable connections. The center LED, of the three LEDs grouped together, will not illuminate if the USB signal from the PC is not active.



NOTE It can take a minute or two for enumeration to occur between the powered USB hub and the PC. Until enumeration is completed, not all the LEDs will be illuminated.

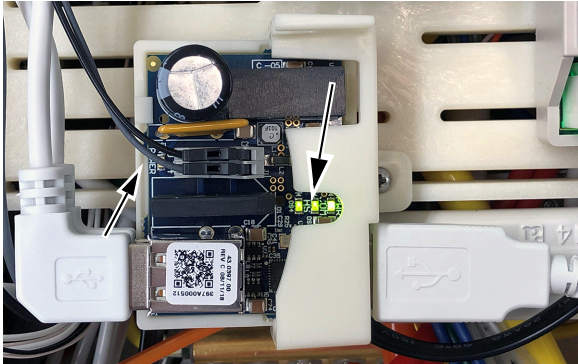

- 5 Verify the green LED on the Mini Dock is illuminated. The LED will not illuminate if the USB input is not active.

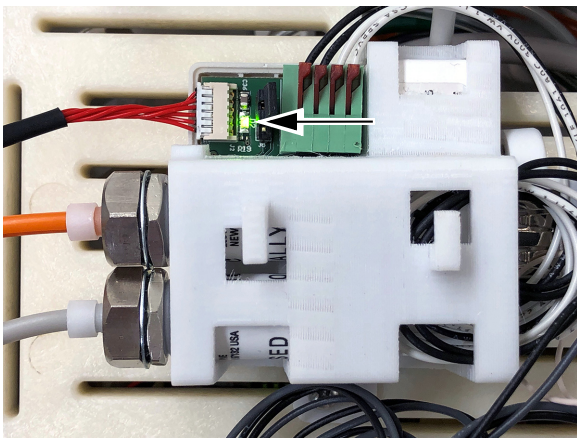

Live Mode Test

- 1 Lift the camera from the holder and verify that the camera LEDs illuminate and the computer displays a live image.

Freeze Mode Test

- 1 Touch the camera lightly or press the footswitch (depending on how the freeze mode jumper was positioned). Verify the image displays on the PC and is frozen.
- 2 Touch the camera again, or press the footswitch, to return to Live mode. Verify that the displayed image is live.
- 3 Touch the camera or press the footswitch to freeze another image. Verify the a new frozen image has replaced the live image.

Reinstall the Covers



CAUTION When removing or replacing covers, take care not to damage any wiring or tubing. Verify that the covers are secure after replacing them.

532B: Reinstall the Top and Front Covers	33
533B: Reinstall the Instrument Pad	34
541B: Reinstall the Delivery System Covers	35

532B: Reinstall the Top and Front Covers

- 1** Reinstall the front cover onto the control head.

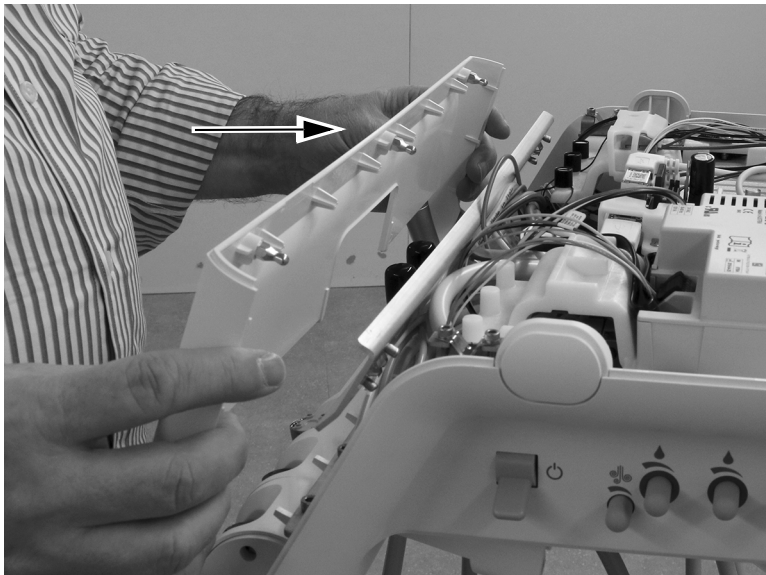

- 2** Place the top cover onto the control head. Squeeze the back of the cover and the control head together to ensure the cover is fully seated on the control head.

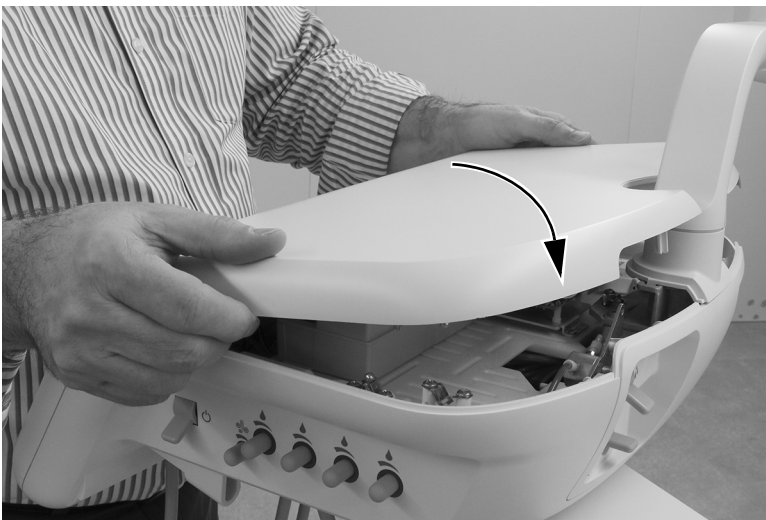

533B: Reinstall the Instrument Pad

- 1 Pull each of the whips behind the removed instrument pad out of the control head.

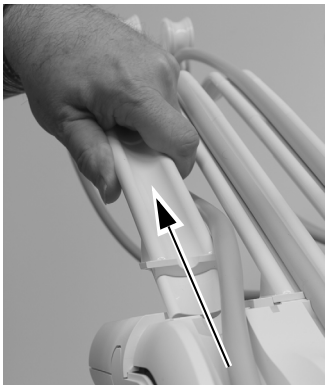

- 2 Replace the instrument pad on the control head and press it into place. Press all around the edges of the instrument pad to ensure that it is fully seated on the control head.



- 3 Insert the whips into the control head. Ensure the top edge of the instrument pad is fully seated before you insert the whips.



- 4 Reinstall the handpiece tubing into the whips.

541B: Reinstall the Delivery System Covers

- 1 Place the top cover on the instrumentation arm and slide the top cover toward the touchpad.

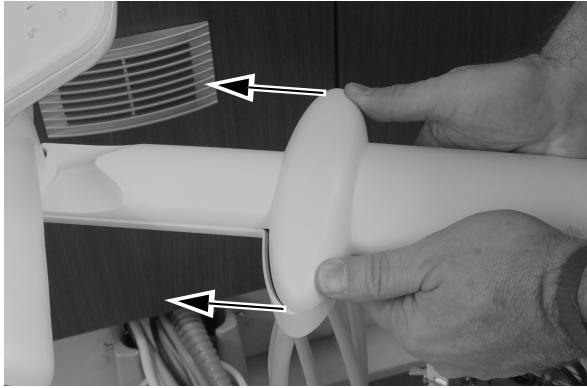

- 2 Use a 5/32" hex key to reinstall the screw that secures the top cover on the instrumentation arm.

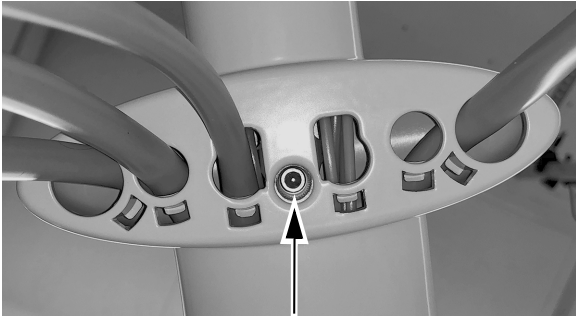

- 3 Reinstall the side covers.



Appendix A: 532B/533B - Change an Active Holder Position to an Inactive Holder Position

If the doctor wants to place the camera in an active holder position, you can change the holder position to an inactive position so that its associated control block position to be reassigned to a currently inactive holder position. Use the following procedure to change a holder position from active to inactive.

- 1 Locate the gray holdback air tubing for the active holder position.

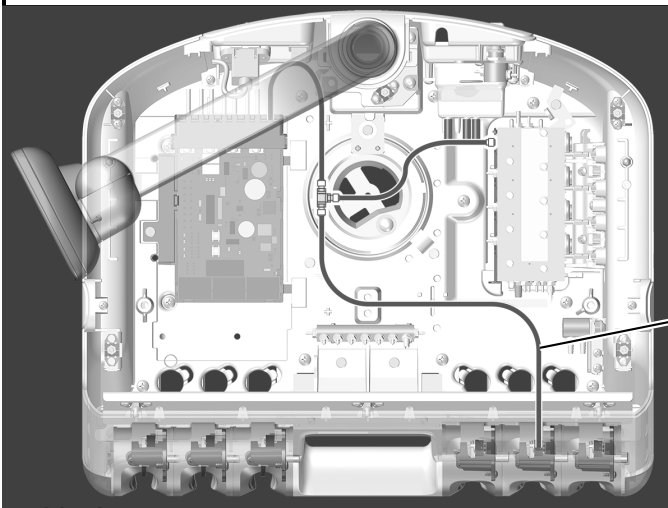

Module shelf is not shown to enhance visibility.

Holdback Air Tubing from Active Holder Position

532B Shown

- 2 Disconnect the desired active holder position holdback air from the from the T-connector that connects the tubing from the circuit board and the control block tubing to the active holder position tubing. Plug the open end of the T-connector.

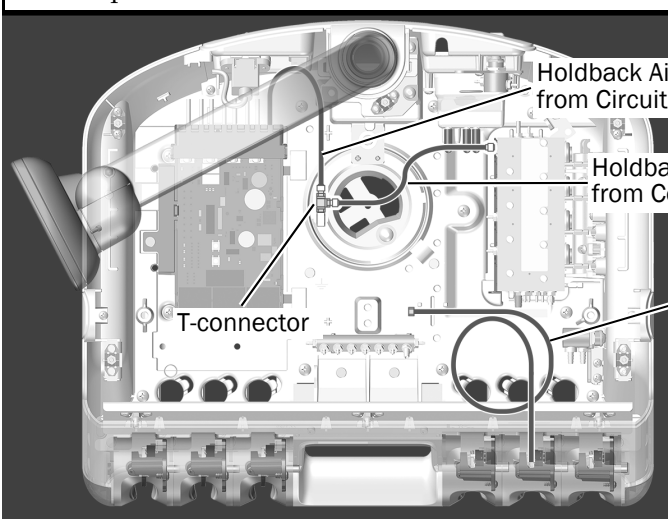

Holdback Air Tubing from Circuit Board

Holdback Air Tubing from Control Block

T-connector

Holdback Air Tubing from Now Inactive Holder Position

- 3 Continue the installation with the procedure "532B: Install the Handpiece Tubing" on page 3 or "533B: Install the Handpiece Tubing" on page 7, as appropriate.

Appendix B: 532B/533B - Change an Inactive Holder Position to an Active Holder Position

If the doctor wants to place the camera in an inactive holder position, you can change the holder position to an active position so that the touchpad displays **Camera** when the camera is lifted out of the holder position. Use the following procedure to change a holder position from inactive to active.

- 1 Locate the gray holdback air tubing for the inactive holder position.

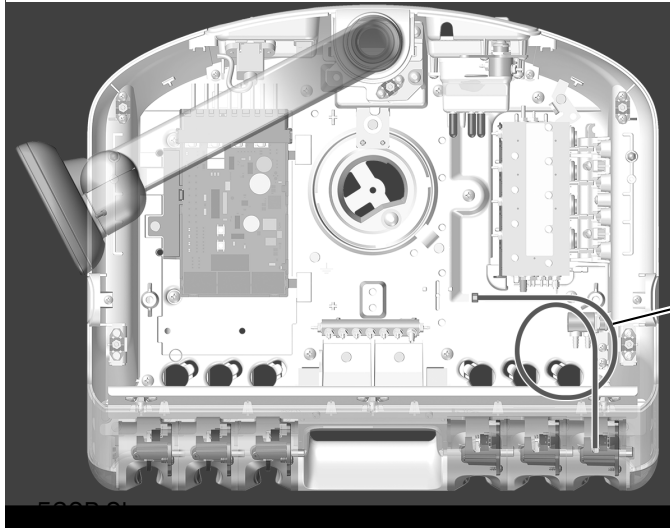

The module shelf is not shown to enhance visibility.

Holdback Air Tubing from Inactive Holder Position

- 2 Connect the desired inactive holder position holdback air to the T-connector that connects the tubing from the circuit board and the control block tubing to the active holder position tubing.

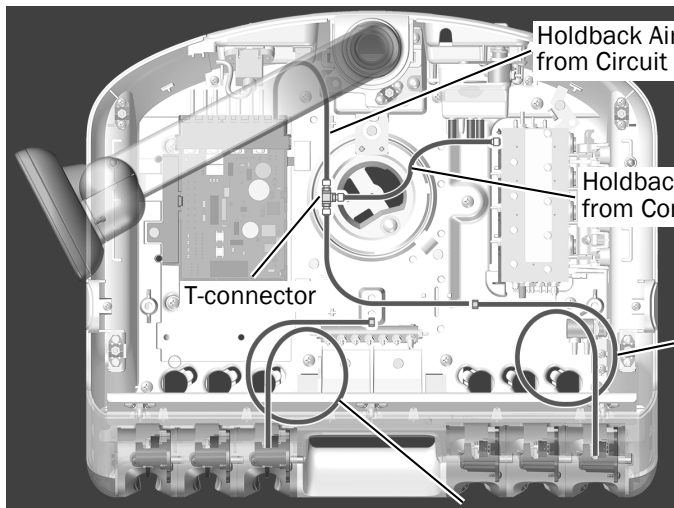

Holdback Air Tubing from Circuit Board

Holdback Air Tubing from Control Block

T-connector

Holdback Air Tubing from Now Active Holder Position

Holdback Air Tubing from Now Inactive Holder Position

- 3 Continue the installation with the procedure "532B: Install the Handpiece Tubing" on page 3 or "533B: Install the Handpiece Tubing" on page 7, as appropriate.

Regulatory Information and Warranty

For required regulatory information and the A-dec warranty, see the *Regulatory Information, Specifications, and Warranty* document (p/n 86.0221.00) available in the Resource Center at www.a-dec.com.

Acteon and Sopro are registered trademarks of Financiere Acteon SAS.



A-dec Headquarters

2601 Crestview Drive
Newberg, OR 97132 USA
Tel: 1.800.547.1883 Within USA/CAN
Tel: +1.503.538.7478 Outside USA/CAN
Fax: 1.503.538.0276
www.a-dec.com

A-dec Inc. makes no warranty of any kind with regard to the content in this document including, but not limited to, the implied warranties of merchantability and fitness for a particular purpose.



86.0765.00 Rev B
Date of Issue 2022-01-07
Copyright 2021 A-dec, Inc.
All rights reserved.
IGrphpor18