

## INSTRUCTIONS FOR USE

# A-dec 500 12 O'Clock Systems

Model 541 Duo and 545 Assistant's

## Copyright

© 2021 A-dec Inc. All rights reserved.

A-dec Inc. makes no warranty of any kind with regard to this material, including, but not limited to, the implied warranties of merchantability and fitness for a particular purpose. A-dec Inc. shall not be held liable for any errors contained herein or any consequential or other damages concerning the furnishing, performance or use of this material. The information in this document is subject to change without notice. If you find any problems in the documentation, please report them to us in writing. A-dec Inc. does not warrant that this document is error-free.

No part of this document may be copied, reproduced, altered, or transmitted in any form or by any means, electronic or mechanical, including photocopying, recording, or by any information storage and retrieval system, without prior written permission from A-dec Inc.

## Trademarks and Additional Intellectual Property Rights

A-dec, the A-dec logo, A-dec Inspire, Cascade, Century Plus, Continental, Decade, ICX, ICV, Performer, Preference, Preference Collection, Preference ICC, Radius, and reliablecreativesolutions are trademarks of A-dec, Inc. and are registered in the United States and other countries. A-dec 500, A-dec 400, A-dec 300, A-dec 200, and EasyFlex are also trademarks of A-dec, Inc. None of the trademarks or trade names in this document may be reproduced, copied, or manipulated in any manner without the express, written approval of the trademark owner.

Certain touchpad symbols and icons are proprietary to A-dec, Inc. Any use of these symbols or icons, in whole or in part, without the express written consent of A-dec, Inc., is strictly prohibited.

## Regulatory Information

For required regulatory information and the A-dec warranty, see the Regulatory Information, Specifications, and Warranty document (p/n 86.0221.00) available in the Resource Center at [www.a-dec.com](http://www.a-dec.com).

## Product Service

Product service is available through your local authorized A-dec dealer. To locate an authorized dealer, or for additional service information, visit [www.a-dec.com](http://www.a-dec.com) or contact A-dec at 1.800.547.1883 in the USA and Canada or 1.503.538.7478 worldwide.

IFUbk10

# CONTENTS

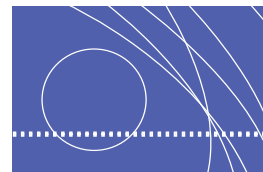

|  |           |
|--|-----------|
| <b>1 Introduction.....</b>                     | <b>1</b>  |
| About Your A-dec 500 12 O’Clock System .....   | 1         |
| <b>2 Basic Operation .....</b>                 | <b>3</b>  |
| Power / Master Toggle.....                     | 3         |
| Handpiece Activation .....                     | 4         |
| Foot Control.....                              | 4         |
| Chip Blower / Accessory Button .....           | 4         |
| Chair Lockout .....                            | 4         |
| Touchpads .....                                | 4         |
| Worksurface and Instrument Positioning.....    | 5         |
| Height Adjustment.....                         | 5         |
| Instrument Positioning.....                    | 5         |
| Self-Contained Water System .....              | 6         |
| Assistant’s and Doctor’s Syringe.....          | 6         |
| Vacuum Instrumentation .....                   | 7         |
| Left/Right Conversion .....                    | 7         |
| Optional Flex-Holder .....                     | 8         |
| <b>3 Touchpad Controls.....</b>                | <b>9</b>  |
| Status Icon.....                               | 10        |
| Chair Positioning .....                        | 10        |
| Program Chair Preset Positions .....           | 11        |
| Customize the X-Ray/Rinse Button .....         | 11        |
| Cuspidor Functions .....                       | 12        |
| Customize Cupfill and Bowl Rinse.....          | 12        |
| Dental Light.....                              | 13        |
| Dental Light Auto On/Off Feature .....         | 13        |
| A/B Button .....                               | 13        |
| Handpiece Settings (Deluxe Touchpad Only)..... | 14        |
| Standard Mode Programming .....                | 14        |
| Forward/Reverse Button .....                   | 15        |
| Endodontics Mode Programming .....             | 16        |
| Other Handpiece Setting Choices .....          | 18        |
| Auxiliary Control Buttons .....                | 18        |
| Touchpad Help Messages .....                   | 18        |
| <b>4 Adjustments and Maintenance .....</b>     | <b>19</b> |
| Syringe Flow Adjustment.....                   | 19        |
| Delivery System Adjustments .....              | 19        |
| Removing Control Covers .....                  | 19        |
| Water Coolant Flow .....                       | 20        |
| Air Coolant Flow .....                         | 20        |
| Drive Air Pressure.....                        | 21        |
| Tray Holder Rotation .....                     | 22        |
| Handpiece Tubing Maintenance .....             | 23        |
| Bulb Replacement for Fiber-Optic Tubing.....   | 23        |

|   |           |
|---|-----------|
| Oil Collector.....  | 24        |
| Solids Collector .....                                    | 25        |
| Utilities .....   | 26        |
| Air and Water Manual Shutoff Valves.....                  | 26        |
| Air-Actuated Air and Water Shutoff Valves .....           | 26        |
| System Air and Water Pressure Adjustments.....            | 26        |
| Air and Water Filter Replacement .....                    | 27        |
| Check for a Clogged Air or Water Filter .....             | 27        |
| Inspect and Replace the Filter .....                      | 27        |
| Water Screen Replacement .....                            | 28        |
| Clean/Maintain .....                                      | 28        |
| HVE/Saliva Ejector Valve Body Assembly Asepsis .....      | 28        |
| Disinfection .....  | 29        |
| Routine Maintenance and Sterilization .....               | 29        |
| HVE/Saliva Ejector Tip Asepsis .....                      | 30        |
| Disposable Tips .....                                     | 30        |
| Sterilizable Tips .....                                   | 30        |
| Barrier Protection .....                                  | 31        |
| Waterline Treatment .....                                 | 31        |
| <b>Appendix: Specifications and Warranty .....</b>        | <b>32</b> |
| Specifications.....                                       | 32        |
| Minimum Air, Water, and Vacuum Service Requirements ..... | 32        |
| HVE and Saliva Ejector Opening for Tips .....             | 32        |
| Warranty .....  | 32        |



# INTRODUCTION

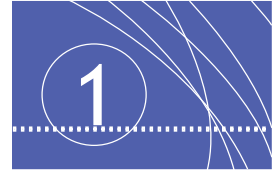

Thank you for choosing A-dec equipment. This guide contains basic operating instructions, adjustments, and maintenance for A-dec 500 systems at 12 o'clock.

## About Your A-dec 500 12 O'Clock System

The A-dec 500 12 o'clock system is floor-mounted and installs with a variety of Preference Collection® and Preference Slimline™ cabinets (see Figure 1). A number of integrated accessories are available with your A-dec 500 system, including highspeed and lowspeed handpieces, electric motors, intraoral cameras, ultrasonic instruments, curing lights, and other options. For an overview of component features and options covered in this guide, see Figure 2 on page 2.

Figure 1. A-dec 541 Duo on a Preference Collection 5580 Treatment Console



Figure 2. A-dec 541 Duo Features\*

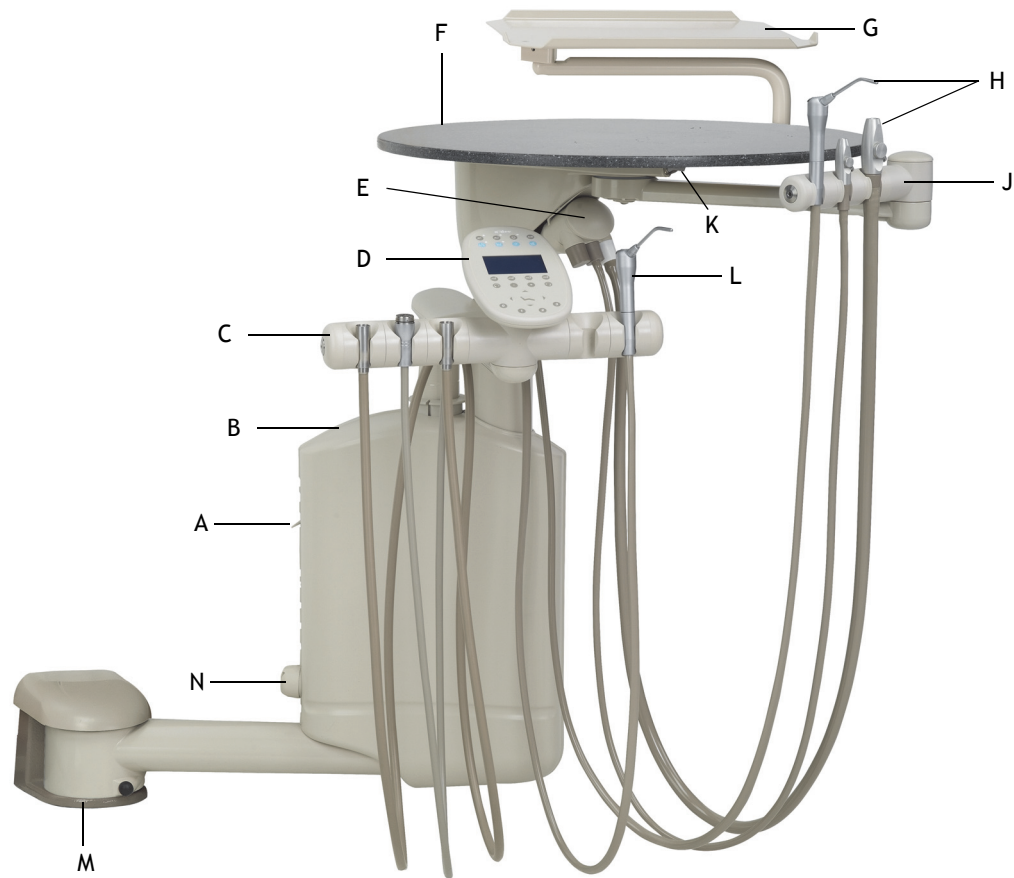

| Item | Description                 |
|------|-----------------------------|
| A    | Flush Toggle                |
| B    | Control Center              |
| C    | Doctor's Holder Assembly    |
| D    | Deluxe Touchpad (optional)  |
| E    | Solids Collector            |
| F    | Worksurface                 |
| G    | Tray Holder (optional)      |
| H    | Assistant's Instrumentation |
| J    | Assistant's Holder Assembly |
| K    | Master Toggle               |
| L    | Doctor's Syringe            |
| M    | Floor Mounting Hub          |
| N    | Oil Collector               |

\*A-dec 545 includes similar features, minus doctor-side controls.

# BASIC OPERATION

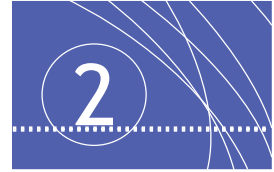

This section includes basic operating instructions for your A-dec 500 delivery system. For touchpad operation, refer to “Touchpad Controls” on page 9.

## Power / Master Toggle

The master toggle controls the power to the delivery system as well as other modules mounted to the chair. Flip the toggle to turn the system on or off.



---

**NOTE** To prolong the life of your equipment, turn off the master toggle when the delivery system is not in use.

---

**Figure 3. Master Toggle Location**

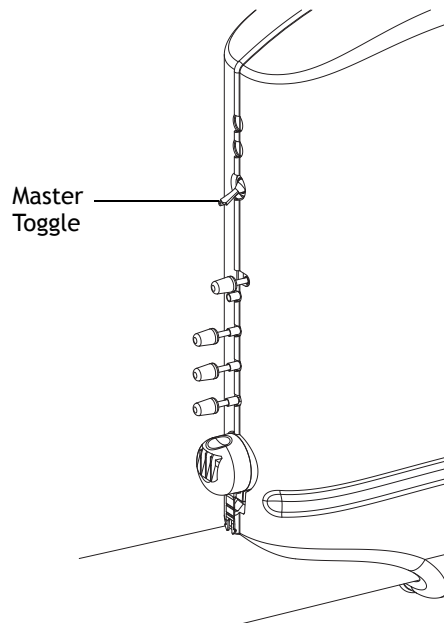

---

**CAUTION** To prevent damage to your delivery system, do not use saline solution, mouth rinses, or any chemical solutions not specified in this guide. Use a water supply system separate from your delivery system if you need to use these types of solutions. As a general rule, you can use drinking water as source water in your delivery system.

For complete instructions on water usage in your A-dec systems, refer to the *A-dec Self-Contained Water System Instructions For Use* (p/n 86.0609.00) included with your equipment.

---

## Handpiece Activation

The handpieces automatically activate when you lift a handpiece from its holder. Press the foot control to operate the activated handpiece.

## Foot Control

The foot control regulates drive air to the active handpiece. It provides an air signal that activates air coolant and water coolant flow. The foot control is equipped with a wet/dry toggle and a chip blower/accessory button (see Figure 4). To turn the water coolant on or off, use your foot to flip the wet/dry toggle.



---

**NOTE** The foot control has additional functionality when used with a deluxe touchpad or an intraoral camera. The wet/dry toggle operates as a three-way switch with the air and water coolant buttons on the touchpad.

---

**Figure 4. Foot Control**

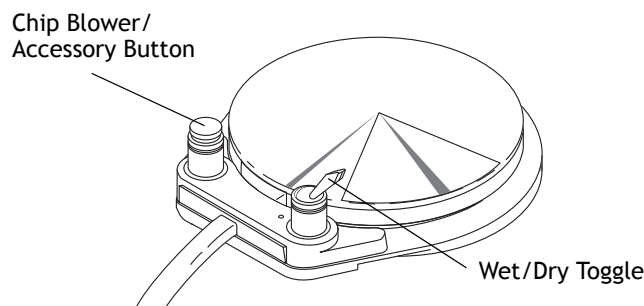

### Chip Blower / Accessory Button

The chip blower/accessory button operates as either a chip blower or an accessory button (see Figure 4). The chip blower function sends a jet of air through the handpiece without activating the handpiece bur.

The accessory button function operates integrated accessory devices. For more details, see your authorized A-dec dealer.

### Chair Lockout

The deluxe touchpad inhibits the operation of the A-dec 511 chair when you remove a handpiece from its holder and step on the foot control. This feature is also available on some later model Performer® and Cascade® chairs and on systems that include an optional lockout kit.

## Touchpads

A-dec 500 touchpads centralize treatment room controls into one touch surface. Some touchpad buttons have indicators to alert you if the operation is functioning. For complete instructions on touchpad operation, see "Touchpad Controls" on page 9.

# Worksurface and Instrument Positioning

The round worksurface and instrument holders are height adjustable and offer flexible instrument positioning.

## Height Adjustment

To adjust the height of the worksurface and the instrumentation arm, lift the upper part of the vertical post (see Figure 5) and slide the height adjustment ring to the desired position. Then lower the vertical post onto the ring.

**Figure 5. Adjust Worksurface and Arm Height**

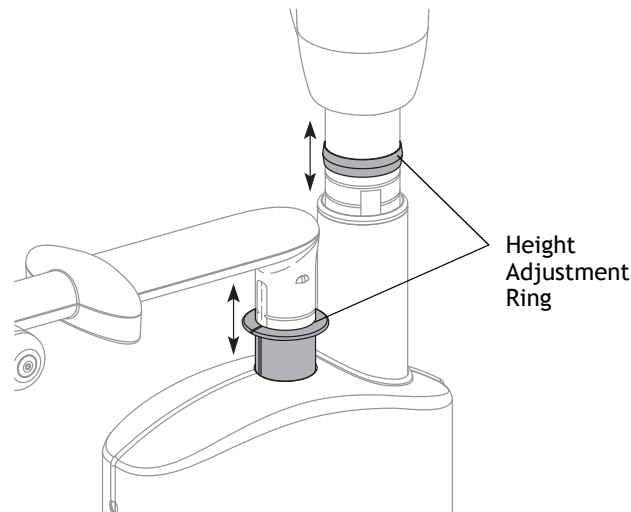

## Instrument Positioning

Instrumentation is delivered from holder assemblies that pivot and rotate to improve positioning (see Figure 6). To adjust each individual holder position:

1. Pull holder slightly away from the adjacent one.
2. Rotate to the desired position and release.

**Figure 6. Adjust Instrument Holder**

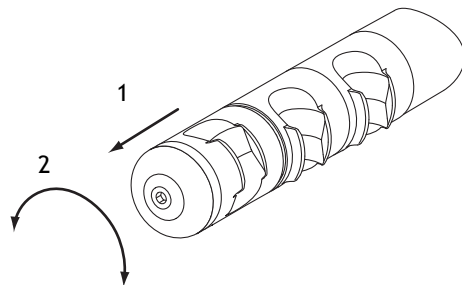

## Self-Contained Water System

The self-contained water system supplies water to handpieces, syringes, and cuspidor cupfill. The system includes a 2-liter, quick-disconnect water bottle that mounts in a remote location inside the cabinet (see Figure 7). For complete instructions on water usage in your A-dec 500 system, refer to the *A-dec Self-Contained Water System Instructions For Use* (p/n 86.0609.00) included with your equipment.

**Figure 7. Remote Self-Contained Water Bottle**



## Assistant's and Doctor's Syringe

To install the A-dec syringe tip, push the tip in until you feel two clicks. Press both buttons simultaneously for the air/water spray.



---

**IMPORTANT** For detailed instructions on syringe usage, flow adjustment, and maintenance, see the *A-dec Syringes Instructions For Use* (p/n 85.0680.00).

---

## Vacuum Instrumentation

The fully autoclavable HVE and saliva ejector include a quick-disconnect feature that allows you to easily remove the valve body from the tubing for simple cleaning and sterilization. To operate the HVE and saliva ejector, simply lift the valve lever (see Figure 8).

**Figure 8. HVE and Saliva Ejector Operation**

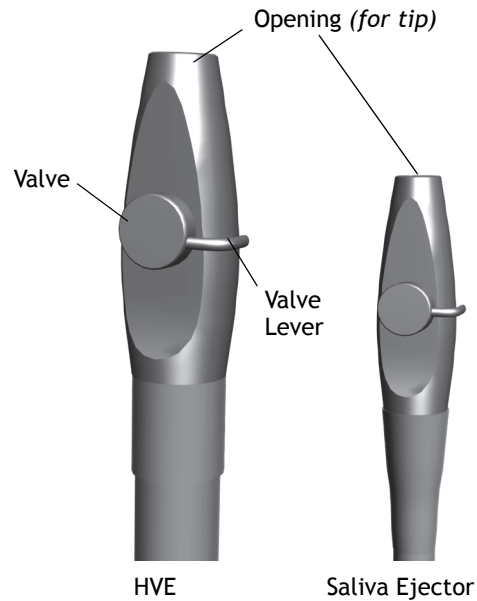

## Left/Right Conversion

The HVE and saliva ejector can easily be converted for right- or left-handed operation. To convert the HVE or saliva ejector to one side or the other, push the valve out of the HVE body by pressing on the small diameter side. Rotate the valve 180°, then push it back into place.

**Figure 9. HVE and Saliva Ejector Left/Right Conversion**

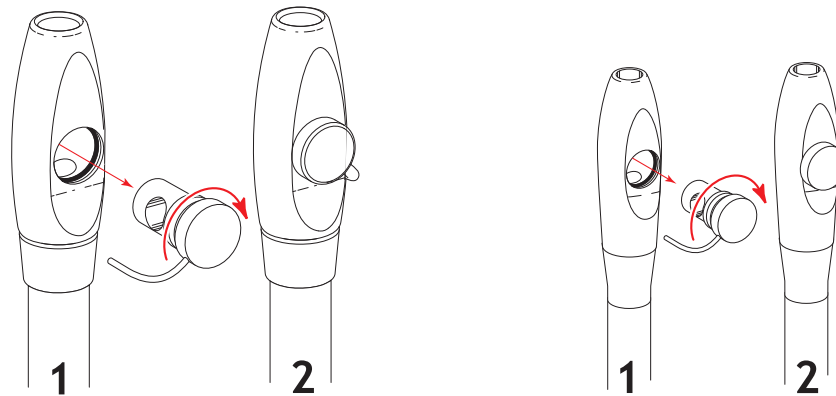

## Optional Flex-Holder

The optional flex-holder is a convenient holder position for additional accessories, such as a curing light, or existing instrumentation (see Figure 10). The holder easily mounts on the round worksurface.

**Figure 10. Optional Flex-Holder**





# TOUCHPAD CONTROLS

Your A-dec 500 12 o'clock system may include a standard or deluxe touchpad. The standard touchpad controls chair, cuspidor, and dental light functions. The deluxe touchpad adds controls for handpieces, electric motors, and several other options.

**Figure 11. Standard and Deluxe Touchpads**



Standard Touchpad

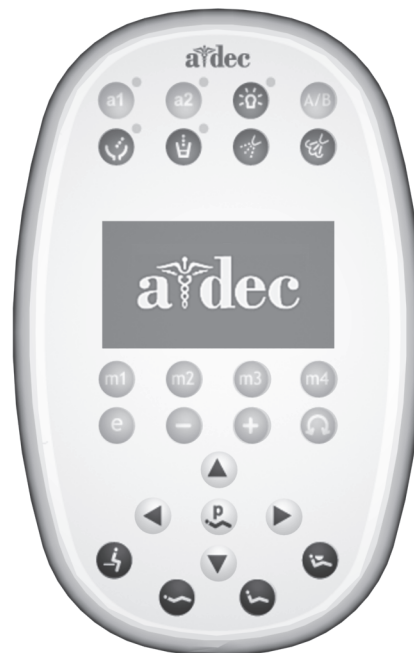

Deluxe Touchpad

*Note: Touchpad symbols are proprietary to A-dec Inc.*

## Status Icon

The A-dec logo on the deluxe touchpad indicates the system status:

- Solid blue – normal operation and power is on Figure 12.
- Blinking – chair stop plate or cuspidor limit switch is active. The icon returns to solid blue once you remove any obstructions.









Figure 12. Status Icon



## Chair Positioning









Your touchpad provides manual and programmed controls for A-dec chair positioning. The direction arrows on the touchpad allow you to manually move the chair base and back up or down (see Table 1).

Table 1. Manual Chair Buttons

| Icon   | Action    |
|--|-----------|
|  OR  | Back down |
|  OR  | Base down |
|  OR  | Back up   |
|  OR  | Base up   |

Four programmable chair buttons, which can be easily customized, automatically move the chair into a factory preset position (see Table 2).

Table 2. Programmable Chair Buttons / Factory Presets

| Button   | Position Description   |
|--|--|
|  OR  | <b>Entry/Exit:</b> Automatically positions chair for entry/exit and turns off dental light.  |
|  OR  | <b>Treatment 1:</b> Automatically positions the chair base and back down and turns on the dental light.  |
|  OR  | <b>Treatment 2:</b> Automatically positions the chair base and back and turns on the dental light.   |
|  OR  | <b>X-ray/Rinse:</b> Automatically positions the chair for either x-ray or rinse. Toggles between the x-ray/rinse and the last manual position, and turns off the dental light. |

## Program Chair Preset Positions



**NOTE** Please follow standard patient care precautions when using the chair preset position functions.

To stop the chair at any point, push any chair positioning button on the footswitch or touchpad.

To program chair preset positions Entry/Exit, Treatment 1, and Treatment 2:

1. Use the manual controls to adjust the chair position as desired (see Figure 13).
2. Press and release the program button ( or ). One beep indicates programming mode.
3. Press the chair position button you wish to reset (for example, press or for Entry/Exit). Three beeps indicates the new setting is programmed into memory.

**Figure 13. Touchpad Chair Position Buttons**

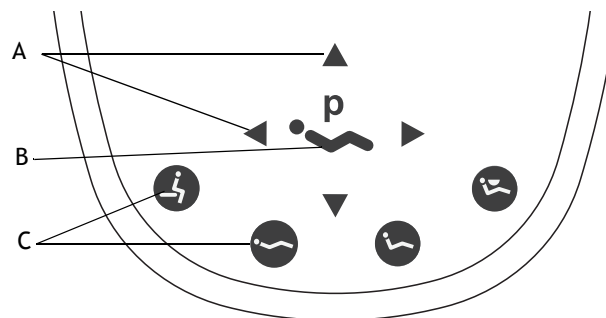

(A) Manual Chair Buttons; (B) Program Button; (C) Programmable Chair Preset Buttons

## Customize the X-Ray/Rinse Button

The X-ray/Rinse button functions either as x-ray/rinse or as another preset position (Treatment 3). To change the function of the X-ray/Rinse button:

1. Press and hold the program button and or simultaneously for three seconds.
  - One beep indicates the button has been configured as Treatment 3.
  - Three beeps indicates that X-ray/Rinse button has been configured as the x-ray/rinse function (toggles between the x-ray/rinse and the previous position).
2. Program the preset position as instructed above, under “Program Chair Preset Positions.”







**TIP** If the X-ray/Rinse button is changed to a preset position, it operates the same as the Treatment buttons 1 and 2.



# Cuspidor Functions

The following table describes the cupfill and bowl rinse buttons:

**Table 3. Cupfill and Bowl Rinse Buttons**

| Button   | Description  |
|--|--|
|  or  | <p><b>Cupfill Button:</b> Controls water flow from the cuspidor into a cup.</p> <ul style="list-style-type: none"> <li>• Press the cupfill button for a timed operation. The factory preset is a 2.5 second fill.</li> <li>• Press and hold the cupfill button for manual operation.</li> </ul>    |
|  or  | <p><b>Bowl Rinse Button:</b> Provides rinse water for the cuspidor bowl.</p> <ul style="list-style-type: none"> <li>• Press the bowl rinse button for a timed operation. The factory preset is a 30 second rinse.</li> <li>• Press and hold the bowl rinse button for manual operation.</li> </ul> |



**TIP** Press the bowl rinse button ( or ) twice in less than two seconds to activate the continuous operation mode. Press the button once to end the continuous bowl rinse mode.

## Customize Cupfill and Bowl Rinse

To program the cupfill and bowl rinse timing:

1. Press and release the program button or, at the cuspidor, press and hold both the cupfill and bowl rinse buttons located near the spout. One beep indicates the programming mode is ready.
2. Press and hold the cupfill or bowl rinse button for the desired amount of time.
3. Release the button. Three beeps confirm the setting.



**NOTE** If your system includes an A-dec relay module, you can use the touchpad *a1* and *a2* or the bowl rinse and cupfill buttons to activate two auxiliary devices. See “Auxiliary Control Buttons” on page 18 for information.

## Dental Light

You can turn the dental light on or off from either the touchpad or the dental light. The dental light button on the touchpad allows you to change intensity settings.

**Halogen Dental Light:** Press  to toggle between high and composite or medium and composite. When the dental light is in composite mode, the indicator light blinks (see Figure 14).





**LED Dental Light:** Press and release  to choose the desired intensity mode. When the light is in cure-safe mode, the indicator light flashes (see Figure 14).

Figure 14. Dental Light Mode

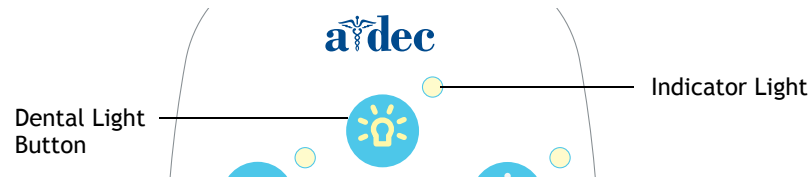

To turn off the dental light, hold down .



## Dental Light Auto On/Off Feature

The dental light has an auto on/off feature. When you use a programmed chair position, the dental light turns on when the chair back reaches operating position. Press Entry/Exit ( or ) or X-ray/Rinse ( or ) and the dental light automatically turns off.



**TIP** If X-ray/Rinse button is changed to a preset position, the dental light auto feature operates the same as the Treatment buttons 1 and 2.

To activate/deactivate:

- Press and hold  and the program button ( or ) simultaneously for three seconds. One beep confirms the dental light auto feature is off. Three beeps confirm that the dental light auto feature is on.

## A/B Button

Deluxe touchpads include an A/B button () that offers you two separate sets of programmable settings. The currently active set is indicated by the A or B in the touchpad display (see Figure 15).

Figure 15. A/B Selection



## Handpiece Settings *(Deluxe Touchpad Only)*

### Standard Mode Programming

Activate the electric motor by lifting the handpiece from the holder. The settings on the display are the ones last used for that handpiece position. The electric motor allows you to choose a precise preset speed. Table 4 lists the factory presets for electric motors:

**Table 4. Electric Motor Speed / Air and Water Coolant Presets (Standard Mode)**

| Memory Setting | Preset Speed | Air Coolant | Water Coolant |
|----------------|--------------|-------------|---------------|
| M1             | 2,000 RPM    | On          | On            |
| M2             | 10,000 RPM   | On          | On            |
| M3             | 20,000 RPM   | On          | On            |
| M4             | 36,000 RPM   | On          | On            |

The deluxe touchpad allows you to program four memory buttons with your specific RPM setting. With the A/B button, you can program two settings for each memory button, for a total of 8 customized settings per handpiece (the endodontic mode offers an additional 8 memory settings).



**NOTE** If two operators use the delivery system, be sure to select the correct operator set (A or B) before changing any memory settings. The currently active set is indicated by the A or B in the touchpad display (see Figure 15 on page 13).

To program the handpiece setting:

1. Press the plus (+) and minus (-) buttons to adjust the RPM. The RPM values are displayed in the display screen (see Figure 16).
2. If desired, press or to change air and water coolant settings.
3. To place the setting into memory, press or . One beep sounds.
4. Choose the desired memory setting by pressing m1, m2, m3, or m4. Three beeps confirm the setting.

Figure 16. Standard Mode Buttons and Settings

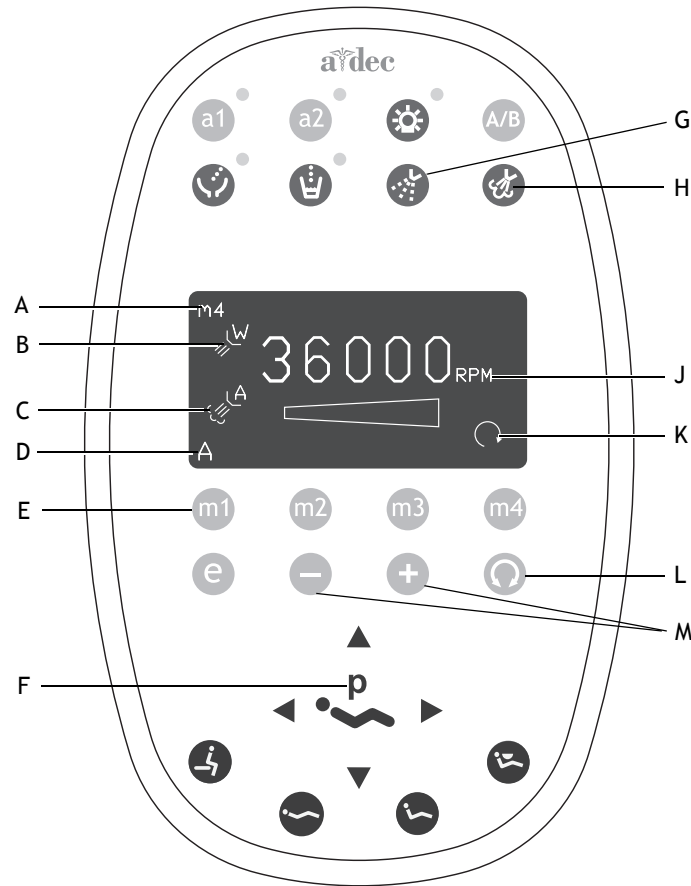

| Item | Description              | Item | Description                   |
|------|--------------------------|------|-------------------------------|
| A    | Memory Setting Indicator | G    | Water Coolant Button          |
| B    | Water Coolant Indicator  | H    | Air Coolant Button            |
| C    | Air Coolant Indicator    | J    | Speed Limit Setting           |
| D    | A/B Operator Indicator   | K    | Forward/Reverse Indicator     |
| E    | Memory Buttons (m1 - m4) | L    | Forward/Reverse Toggle Button |
| F    | Program Button           | M    | Adjustment Buttons            |

## Forward/Reverse Button

The forward/reverse button (see Figure 16) changes the electric motor's direction. The system defaults to the forward position when you return the motor to the holder or turn off the system. In reverse mode, the screen icon flashes continuously.



**NOTE** You can also use the foot control to easily switch between forward and reverse. When the motor has stopped, tap the accessory (chip/air) button to change the direction.

## Endodontics Mode Programming

In addition to handpiece speed adjustments, the Endodontics mode allows you to change a number of settings based on the specific file and desired handpiece behavior. Icons in the touchpad window reflect the settings (see Figure 17).



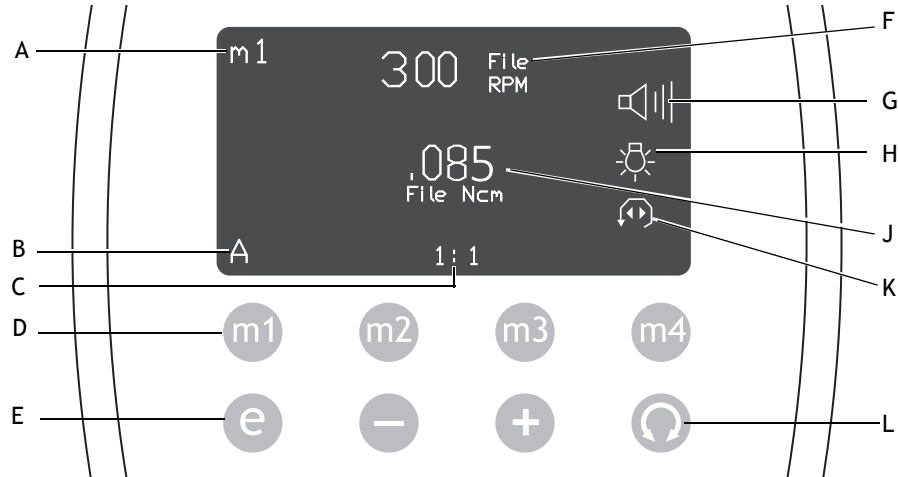

**NOTE** For more information regarding speed limit and torque limit for a specific file, consult the file manufacturer.

Figure 17. Endodontics Mode Buttons and Settings



| Item | Description                    | Item | Description                               |
|------|--------------------------------|------|---|
| A    | Memory Setting Indicator       | G    | Warning Beep Indicator                    |
| B    | A/B Operator Indicator         | H    | Endodontics Light Indicator               |
| C    | Attachment Ratio Setting       | J    | File Torque Limit/Unit Indicator          |
| D    | Memory Buttons (m1 - m4)       | K    | Forward/Reverse and Torque Mode Indicator |
| E    | Endodontics Mode Toggle Button | L    | Forward/Reverse Toggle Button             |
| F    | File Speed Setting             |      |   |











To change a setting:

1. Lift the handpiece from the holder.
2. If the touchpad window is not in Endodontics mode, press **e** or **E**.  
The endodontics screen is displayed.
3. Press the plus (+) or minus (-) button to activate the Endodontics change mode.  
A white reverse video box appears.
4. Use the chair positioning buttons to move from setting to setting on the display.
5. Use the + and - buttons to change the setting as desired.
6. To place the speed limit, torque limit, and ratio into memory, press  or , then the memory button you want to set. Three beeps confirm the setting.



The following table defines the touchpad display icons for the Endodontics mode:

**Table 5. Endodontics Mode Settings**

| Icon  | Setting       | Description  |
|---|---------------|--|
|                    | Speed         | Setpoint for file speed limit. For more information, consult your file manufacturer.   |
|                    | Torque        | Setpoint for file torque limit. For more information, consult your file manufacturer.  |
|                    | Torque Units  | Toggles between Ncm (Newton centimeters) and gcm (Gram centimeters). Adjusting this setting for one handpiece changes it for all handpiece settings.<br><b>Note:</b> 1 Ncm=102 gcm   |
|                    | Ratio         | Sets the handpiece ratio. For more information, consult your handpiece manufacturer.   |
|                    | Air Coolant   | On/Off—when active, supplies air coolant to the handpiece.   |
|                    | Water Coolant | On/Off—when active, supplies water coolant to the handpiece.   |
|                    | Light Source  | Enables/Disables endodontics handpiece light source.   |
| <br>Auto Off       | Torque Mode   | Adjusting this setting for one handpiece changes it for all handpiece settings. This icon appears with the forward/reverse indicator. <ul style="list-style-type: none"> <li>• Auto-off—the motor shuts off when the file speed reaches the torque limit.</li> <li>• Auto-reverse—the motor stops and reverses direction when the file reaches the torque limit.</li> <li>• Auto-forward—when the file reaches the torque limit, the motor stops, reverses 3 turns, then changes back to forward again. <b>Note:</b> If the file is stuck, this cycle repeats three times before the motor stops.</li> </ul> |
| <br>Auto Reverse |               |  |
| <br>Auto Forward |               |  |
|                  | Beeper        | On/Off—when active, warning beep sounds when you approach torque limit and double beeps when the file auto-reverses. Adjusting this setting for one handpiece changes it for all handpiece positions.  |

## Other Handpiece Setting Choices

Additional system choices are available. Consult your dealer to globally change to any of these setting options:

- **Auto-Off Delay** – The amount of time the handpiece remains lit when idle. The default is 5 seconds. Stepping on the foot control refreshes the delay and the lamp relights. The light stays on as long as you depress the foot control.
- **Light Source Auto On/Off** – When active, the handpiece light automatically turns on when you lift the handpiece from the holder. Default in standard mode is On; in endodontics mode is Off.
- **Voltage** – Depending on your brightness preference and the bulb manufacturer's usage guidelines, the voltage setting adjustment for each handpiece light source.

## Auxiliary Control Buttons

If your system includes an A-dec relay module, you can use the touchpad to activate two auxiliary devices. On deluxe touchpads, use the *a1* and *a2* buttons to activate these devices (see Figure 18). For systems with a standard touchpad, the bowl rinse and cupfill buttons serve as the auxiliary controls.

Figure 18. A1 / A2 Buttons

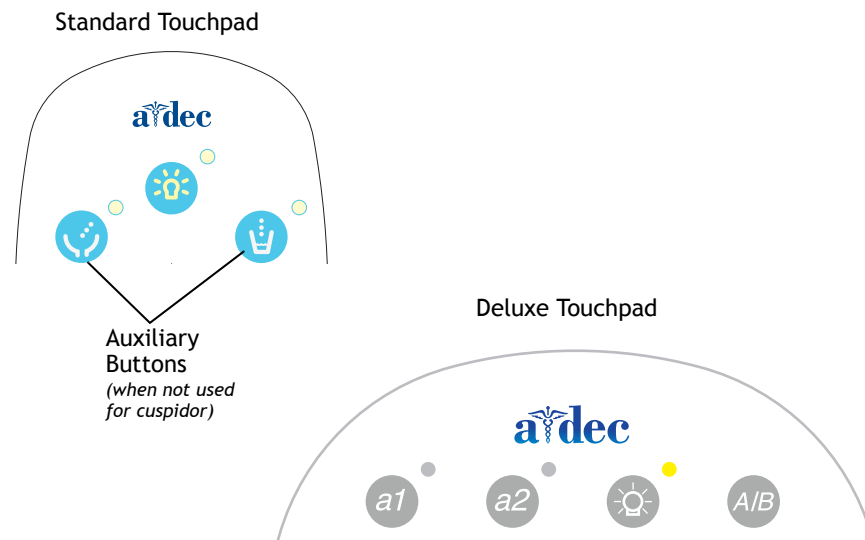

## Touchpad Help Messages

Help messages are displayed on the deluxe touchpad screen to provide information about why an operation is disabled. For information on help messages, see the *Regulatory Information, Specifications, and Warranty* document (p/n 86.0221.00), which is available in the Resource Center at [www.a-dec.com](http://www.a-dec.com).

# ADJUSTMENTS AND MAINTENANCE



## Syringe Flow Adjustment

For syringe water and air flow adjustments, refer to your *A-dec Syringes Instructions For Use* (p/n 85.0680.00).

## Delivery System Adjustments

A-dec 500 delivery systems supply and regulate air and water to operate dental handpieces, syringes, and ancillary devices. You can adjust the delivery system water coolant flow, air flow, and drive air pressure.



---

**CAUTION** When removing or replacing covers, take care not to damage any wiring or tubing. Verify that the covers are secure after replacing them.

---

### Removing Control Covers

To perform some adjustments on the A-dec 541 duo delivery system, you must remove the control center covers. To remove them, locate the hole directly under the delivery system and pull the covers apart (see Figure 19). To replace, position the covers over the delivery system and snap together.

**Figure 19. Opening for Cover Removal**

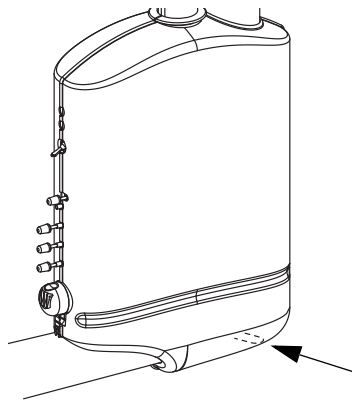
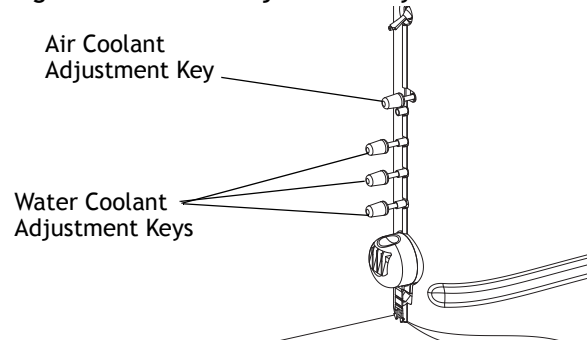

Figure 20. Coolant Adjustment Keys Water Coolant Flow



## Water Coolant Flow

The system provides water coolant flow control for each handpiece. Use the adjustment key to complete the adjustments (see Figure 20):

1. Turn the drive air, air coolant, and water coolant all the way down (clockwise). For instructions on accessing drive air pressure controls, "Drive Air Pressure" on page 21.



---

**NOTE** Air and water coolant adjustment keys are not intended to completely shut off flow.

---

2. Lift a handpiece from the holder.
3. Turn the water coolant on using the footswitch wet/dry toggle or touchpad.
4. Press the foot control to activate the handpiece.
5. Use the adjustment keys on the side of the control head to adjust the water coolant flow (normally about 1 - 2 drops per second). Turn the key clockwise to decrease flow and counterclockwise to increase flow.

## Air Coolant Flow

The air coolant flow control adjusts the air coolant flow to all handpieces. Use the adjustment key to complete the adjustment.

To adjust the air coolant:

1. Lift the handpiece from the holder.
2. If your system has a deluxe touchpad, use it to verify air coolant is on.
3. Insert an adjustment key into the air coolant flow control.
4. Press the foot control to activate the handpiece.
5. Adjust the air coolant flow to fit your needs. Turn the key clockwise to decrease flow and counterclockwise to increase flow.



---

**CAUTION** Do not turn the drive air or air coolant adjustment keys left beyond where the air coolant no longer increases. The stem may come completely out.

---

## Drive Air Pressure

The digital drive air pressure gauge is located inside the control head. The gauge indicates the drive air pressure (in psi) as it leaves the control block to the active handpiece. The drive air pressure controls adjust the drive air pressure for each handpiece (see Figure 21).



**NOTE** Use a handpiece pressure gauge attached to the handpiece tubing for exact drive air measurement. One bar equals 14.5 psi.

**Figure 21. Drive Air Adjustment**

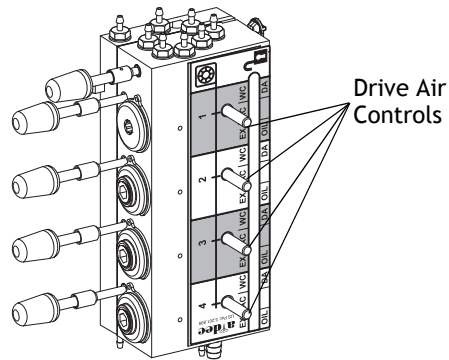

To adjust the drive air pressure, complete these steps for each handpiece (see Figure 21).

1. Lift handpiece tubing; locate drive air pressure gauge and controls inside the control head.
2. Press the foot control.
3. With the handpiece running, watch the gauge and adjust the handpiece drive air pressure to meet manufacturer's specifications. Turn the control clockwise to decrease flow and counterclockwise to increase flow.



**NOTE** Refer to your handpiece documentation for the manufacturer's drive air pressure specifications.

## Tray Holder Rotation

If the tray holder rotation is too tight or too loose, use a hex key to adjust the tension:

1. Insert a hex key through the mounting bracket (see Figure 22). If necessary, rotate the tray holder or arm until the key slides completely into the mounting bracket.
2. While holding the bracket stationary, turn the tray holder or arm right to increase the tension or left to reduce the tension.

**Figure 22. Adjust Tray Holder Rotation (Traditional Control Head)**

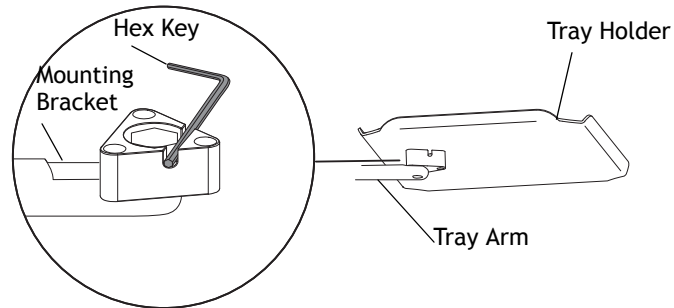

*Note: Tray holder removed for clarity.*

## Handpiece Tubing Maintenance

Use the handpiece tubing flush system to move more water through the tubings in less time than using the foot control. After each patient:

1. Disconnect the handpieces before flushing the tubings.
2. Gather handpiece tubings that use water coolant and hold them over a sink, cuspidor bowl, or basin so the water is directed away from you and into the receptacle.

**Figure 23. Flush Tubings**

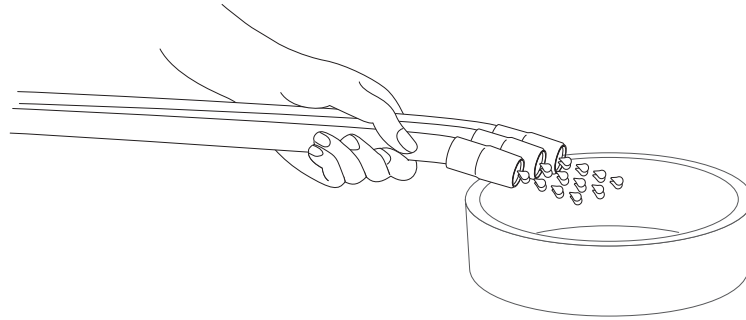

3. Locate the flush toggle on the side of the control center.
4. Hold the toggle down for 20–30 seconds.



**NOTE** Discharge all tubing air and water lines for 20– 30 seconds after each patient.

**Figure 24. Flush Toggle Location**

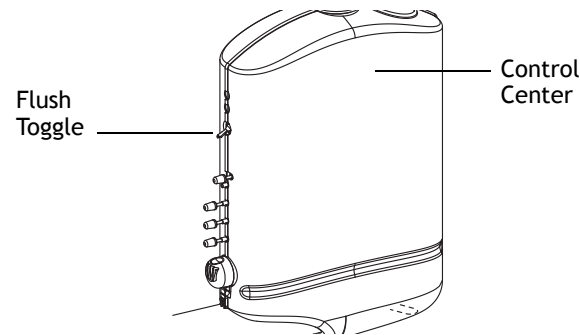

## Bulb Replacement for Fiber-Optic Tubing

Follow these steps to replace the bulb in fiber-optic 5-hole silicone or vinyl tubing.

1. Disconnect the handpiece and swivel quick-connector from the tubing.
2. Pull back the metal handpiece nut. See Figure 25 on page 24.
3. Silicone tubing only: Slide back the metal portion of the handpiece terminal.
4. Replace the bulb. Silicone tubing only: To avoid the possibility of breaking the bulb, insert the bulb into the socket. Then, insert the bulb tip into the recess before lowering the socket and sliding the bulb fully into the recess.
5. Silicone tubing only: Reinsert the metal portion of the terminal into the plastic portion.

- Carefully slide the handpiece nut back over the terminal and reconnect the tubing to the swivel quick-connector and handpiece.

**Figure 25. Bulb Replacement**

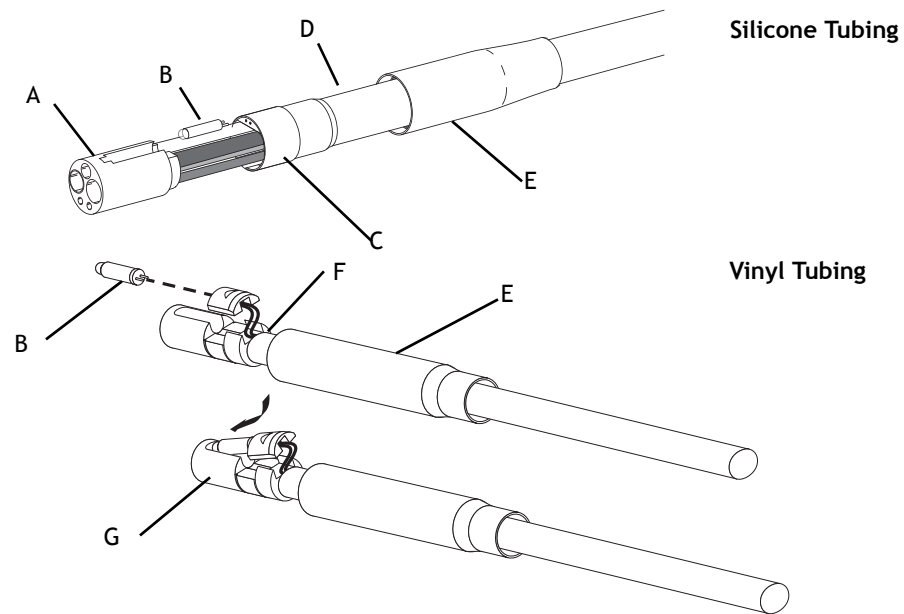

(A) Plastic Handpiece Terminal; (B) Bulb; (C) Metal Portion of Handpiece Terminal; (D) Silicone Tubing; (E) Metal Handpiece Nut; (F) Vinyl Tubing; (G) Metal Handpiece Terminal

## Oil Collector

Service the oil collector on the delivery system once a week for normal use and more often for heavier use. To service:

- Unsnap the oil collector cover on the side of the unit (see Figure 26).
- Discard the old gauze.
- Fold a new square gauze pad (2" x 2", 51mm x 51mm) into quarters and place inside the cover.
- Snap the oil collector cover closed.

**Figure 26. Remove Oil Collector**

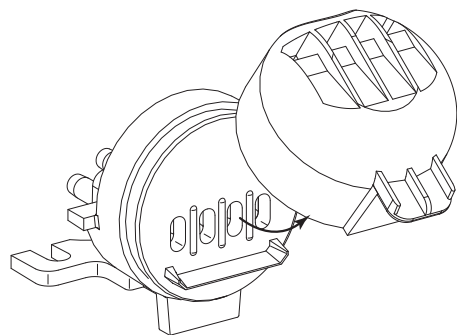



# Solids Collector

The solids collector helps prevent solids from entering the central vacuum system. To ensure proper suction from the central vacuum and maintain proper treatment room asepsis, discard and replace the solids collector screen at least twice a week (see Figure 27).



**TIP** For replacement screens, contact your authorized A-dec dealer and reference Pinnacle p/n 5512 or A-dec p/n 11.1284.01.

**Figure 27. Replace Solids Collector Screen**

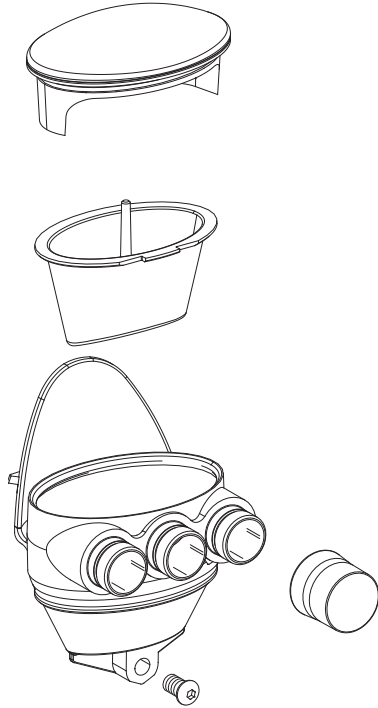

To replace the solids collector screen:



**DANGER** Infectious waste may be present. Follow asepsis protocol to prevent cross contamination.

1. Turn off vacuum or open the HVE control valve.
2. Remove the solids collector cap.
3. Remove the solids collector screen.
4. Discard the screen according to your local regulations.



**CAUTION** Do not empty the screen into your cuspidor. Doing so could plug the drain.

5. Insert new screen in the collector and replace the cap.

## Utilities

The utilities for A-dec 500 12 o'clock systems are located in the cabinet. To access the utilities, lift up the removable cabinet panel. The utilities include the air/water shutoff valves, filters, pressure pre-regulators, vacuum line, and electrical outlets (see Figure 28).

**Figure 28. System Utilities**

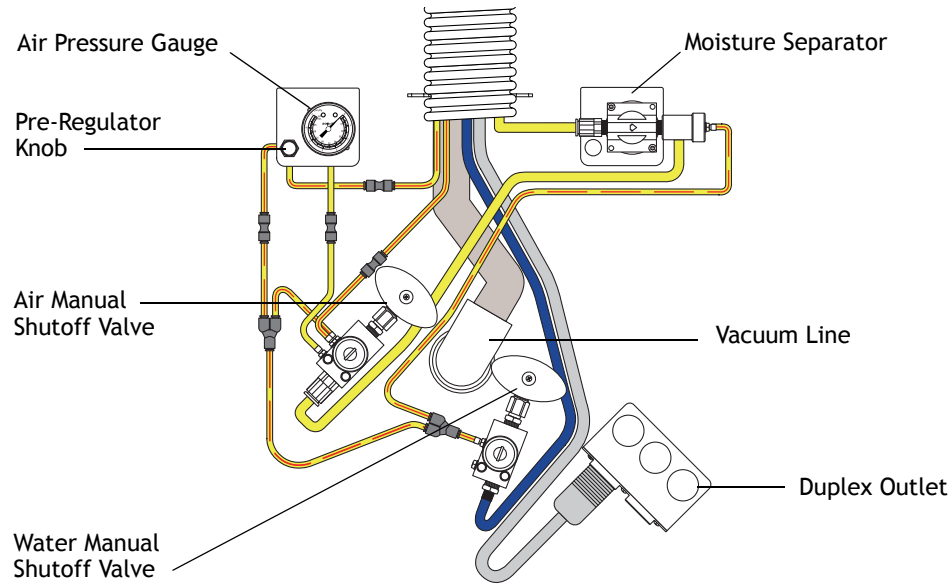

### Air and Water Manual Shutoff Valves

Shutoff valves control the air and water to the unit. To prevent leaks, these valves should remain fully open (turned counterclockwise) except while your unit is being serviced.

### Air-Actuated Air and Water Shutoff Valves

The air-actuated air and water shutoff valves automatically shut off air and water to the system when the master toggle is in the Off position. This safety feature prevents water damage in the event of a water leak while the unit is unattended.

### System Air and Water Pressure Adjustments

Before making any adjustments, verify that the air compressor is turned on, and that it maintains 80–100 psi pressure in the tank. If it doesn't, refer to the compressor instructions.

To adjust air or water pressure:

1. Fully open manual shutoff valves (counterclockwise).
2. Turn the system on and check the pressure gauge (see Figure 28 on page 26). Air pressure should be 70-80 psi.

3. While watching the gauge, operate the syringe. If the system air pressure drops by more than 15 psi, check for clogged filters (see Figure 29).
4. If adjustment of the air or water pressure is required, turn the appropriate pre-regulator knob clockwise to increase pressure, or counterclockwise to decrease.

## Air and Water Filter Replacement

Air and water pass through separate filters before entering the regulators. Replace a filter when it becomes clogged and causes restricted flow (see Figure 29).

**Figure 29. Air and Water Filter Replacement**

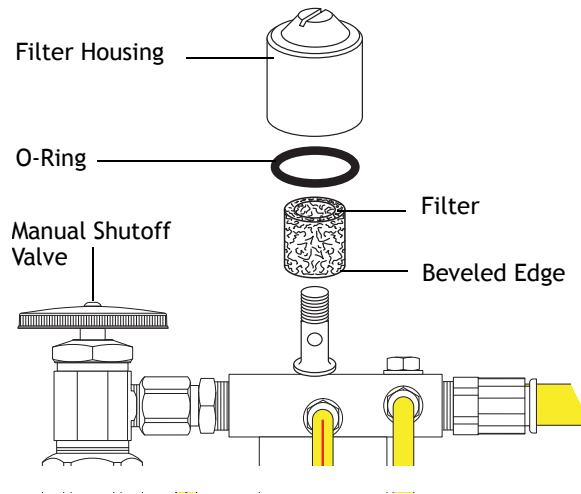

### Check for a Clogged Air or Water Filter

1. Flip the master toggle to On.
2. While watching the air pressure gauge, press the syringe air button (see Figure 28 on page 26). If the system air pressure drops by any more than 15 psi, replace the filter.
3. While watching the cuspidor, press the bowl rinse button. If the bowl rinse water pressure fades or if the water flow stops, replace the filter.

### Inspect and Replace the Filter

1. Flip the master toggle to Off.
2. Close the manual shutoff valves (turn right) (see Figure 29).
3. Bleed the system of air and water pressure by operating the syringe buttons until air and water no longer flow.
4. Using a standard screwdriver, remove the filter housing from the air or water pre-regulator assembly and remove the filter.
5. Replace the filter if it is clogged or discolored; install the filter with the beveled edge facing the manifold.



**NOTE** To ensure proper delivery system operation, make sure to install the filter with the beveled edge facing the manifold (see Figure 29).

## Water Screen Replacement

The manual water shutoff valve comes with a screen to prevent debris from entering the delivery system (see Figure 30). Periodically check and replace this screen to ensure unrestricted water flow to your delivery system.

To remove or replace a screen:

1. Flip the master On/Off toggle to Off.
2. Close the manual water shutoff valve (turn right) (see Figure 30).
3. Using a 5/8" or adjustable wrench, loosen the compression nut on the manual water shutoff valve and pull the water regulator out of the shutoff valve (see Figure 30).
4. Remove the screen and install the replacement screen.
5. Reposition the water regulator in the manual shutoff valve outlet and tighten the compression nut.
6. Open the manual water shutoff valve (turn left).
7. Flip the master On/Off toggle to On, and then check the fittings for leaks.

Figure 30. Water Screen Replacement

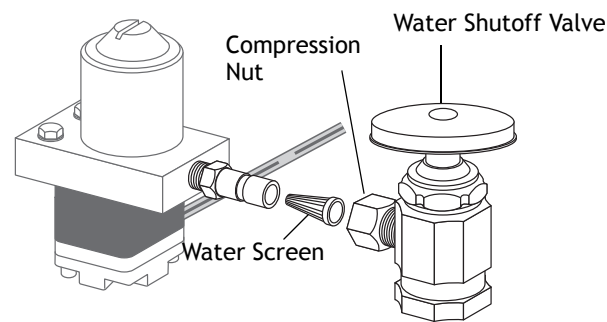

## Clean/Maintain

### HVE/Saliva Ejector Valve Body Assembly Asepsis

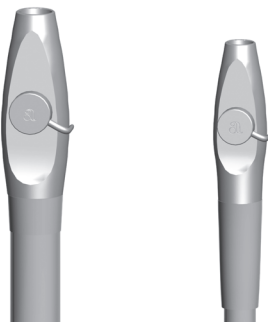

---

**NOTE** Vacuum-lines should be cleaned at the end of each day by evacuating a detergent or water-based detergent-disinfectant through the system.

---

If you use barrier film to protect the main body of the HVE and saliva ejector, replace the barrier film after each patient. Clean and disinfect these instruments at the end of each day or after each patient if the barrier film has been compromised. If you do not use barrier film, or if you perform oral surgery, always clean and disinfect these instruments after each patient.

### Disinfection

To disinfect the HVE and saliva ejector valve body assembly without disconnection from the vacuum system:

1. Remove the vacuum tip from the HVE or saliva ejector.
2. Disinfect the valve body assembly by using an intermediate-level disinfectant according to instructions for the disinfectant; A dec recommends a phenolic (dual) water-based disinfectant.
3. Follow the manufacturer's instructions for disinfectant contact time.
4. Operate the HVE and the saliva ejector valves several times to verify that they rotate smoothly.

### Routine Maintenance and Sterilization



---

**NOTE** A-dec valve body assemblies are heat tolerant for sterilization. Users may sterilize at their discretion.

---

To routinely maintain and sterilize the HVE and saliva ejector when disconnected from the vacuum system (frequency determined by the user):

1. Turn off the vacuum or open the control valve before disconnecting the HVE or saliva ejector.
2. Remove the vacuum tip from the HVE or saliva ejector. Discard disposable vacuum tips.
3. Remove the HVE or saliva ejector valve body assembly from the vacuum line by pulling it away from the tubing at the tailpiece.
4. Disassemble the valve body assembly by pushing the control valve out of the HVE or saliva ejector valve body.
5. Inspect the O-rings. Remove and discard if damaged.
6. Clean undamaged O-rings with a soft brush and a health authority approved detergent. O-rings may be cleaned in place or removed and cleaned at the discretion of the user.
7. Clean all exterior and interior surfaces of the valve body and control valve using a health authority approved detergent and the brushes provided with the product (or equivalent). Lumens or channels of the valve body must be cleaned with a brush of the proper length and diameter. The brush must be long enough to extend through the lumen.
8. Rinse thoroughly with water.
9. Process the disassembled valve body assembly components through a washer-disinfector. If a washer-disinfector is unavailable, valve body assembly components must be manually disinfected using a health authority approved disinfectant.
10. Allow the components to dry completely.
11. Sterilize the valve body assembly components at 132-134°C (270-273°F) for 4 minutes in a pre-vacuum sterilizer or at 132-134°C (270-273°F) for 6 minutes in a gravity displacement sterilizer.

12. Prior to use, replace O-rings as needed, lubricate O-rings with A-dec silicone lubricant, and reassemble the valve body assembly.



---

**CAUTION** Use only silicone lubricant when lubricating instrumentation O-rings. Petroleum-based products will cause permanent damage to the O-rings.

---

13. Reinstall the valve body assembly on the tubing tailpiece.
14. Operate the HVE and the saliva ejector control valves several times to verify that they rotate smoothly.

## HVE/Saliva Ejector Tip Asepsis



---

**NOTE** Select tips that are compatible with your HVE and saliva ejector openings. See “HVE and Saliva Ejector Opening for Tips” on page 32 for specifications.

---

### Disposable Tips

Heat sterilize stainless steel HVE tips after each use. If you are using disposable HVE and saliva ejector tips, replace them with new tips after each use.



---

**CAUTION** Disposable HVE and saliva ejector tips are not sterilizable and should not be reused.

---



### Sterilizable Tips

To clean and sterilize a stainless steel HVE tip:

1. Remove the tip from the HVE.
2. Clean and rinse the tip using a mild detergent and water, then allow the tip to dry completely.
3. Sterilize at 132-134°C (270-273°F) for 4 minutes in a pre-vacuum sterilizer or at 132-134°C (270-273°F) for 6 minutes in a gravity displacement sterilizer.

## Barrier Protection

A-dec recommends barrier protection for all applicable touch and transfer surfaces. Touch surfaces are areas that come into contact with hands and become potential cross-contamination points during dental procedures. Transfer surfaces are areas that come into contact with instruments and other inanimate objects.

In the USA, barriers must be produced under the Current Good Manufacturing Practice (CGMP) as specified by the U.S. Food and Drug Administration (USFDA). For regions outside the USA, refer to the medical device regulations specific to your location.

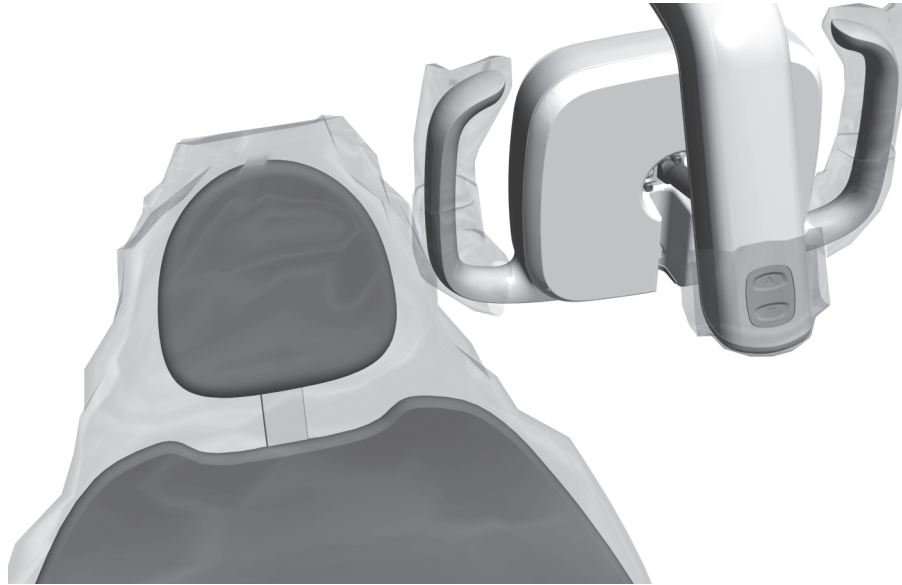

---

**CAUTION** If you use barriers, always replace the barrier film after each patient.

---



---

**IMPORTANT** For recommendations on cleaning and chemical disinfection of touch and transfer surfaces (where barrier protection is not applicable or when barriers are compromised), please see the *A-dec Equipment Asepsis Guide* (p/n 85.0696.00) included with your equipment. This document is also available at [www.a-dec.com](http://www.a-dec.com) in the Resource Center.

---

## Waterline Treatment

For recommended treatment of your dental unit waterlines, refer to the *A-dec Self-Contained Water System Instructions For Use* (p/n 86.0609.00).

# APPENDIX: SPECIFICATIONS AND WARRANTY

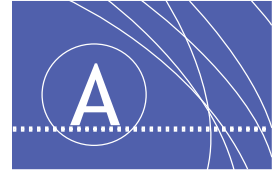

## Specifications

### Minimum Air, Water, and Vacuum Service Requirements

Air: 2.50 scfm (70.80 l/min) at 80 psi (551 kPa)

Water: 1.50 gpm (5.68 l/min) at 40 psi (276 kPa)

Vacuum: 12 cfm (339.84 l/min) at 8 inches of mercury (27 kPa)

### HVE and Saliva Ejector Opening for Tips

A-dec Standard HVE:  $0.435" \pm 0.006"$  ( $11.05 \pm 0.15$  mm)

A-dec 15 mm HVE: 0.592" (14.8 mm)

A-dec saliva ejector:  $0.265 \pm 0.006"$  ( $6.73 \pm 0.15$  mm)

For electrical specifications, identification of symbols, and other regulatory requirements, refer to the *Regulatory Information, Specifications, and Warranty* document (p/n 86.0221.00) included with your equipment.



---

**NOTE** Specifications are subject to change without notice. Some requirements may vary from country to country. For more information, contact your authorized A-dec dealer.

---

## Warranty

Warranty information is provided in the *Regulatory Information, Specifications, and Warranty* document (p/n 86.0221.00), which is available in the Resource Center at [www.a-dec.com](http://www.a-dec.com).











 **A-dec Headquarters**

2601 Crestview Drive  
Newberg, Oregon 97132  
United States  
Tel: 1.800.547.1883 within USA/CAN  
Tel: +1.503.538.7478 outside USA/CAN  
Fax: 1.503.538.0276  
[www.a-dec.com](http://www.a-dec.com)

**A-dec Australia**

Unit 8  
5-9 Ricketty Street  
Mascot, NSW 2020  
Australia  
Tel: 1.800.225.010 within AUS  
Tel: +61.(0).2.8332.4000 outside AUS

**A-dec China**

A-dec (Hangzhou) Dental Equipment Co., Ltd.  
528 Shunfeng Road  
Qianjiang Economic Development Zone  
Hangzhou 311106  
Zhejiang, China  
Tel: +1.503.538.7478

**A-dec United Kingdom**

Austin House, 11 Liberty Way  
Nuneaton, Warwickshire CV11 6RZ  
England  
Tel: 0800.ADEC.UK (2332.85) within UK  
Tel: +44.(0).24.7635.0901 outside UK

**CE**  
**1434**



86.0605.00 Rev J  
Date of Issue 2021-05-07  
Copyright 2021 A-dec, Inc.  
All rights reserved.