

# A-dec 511 Floor Box

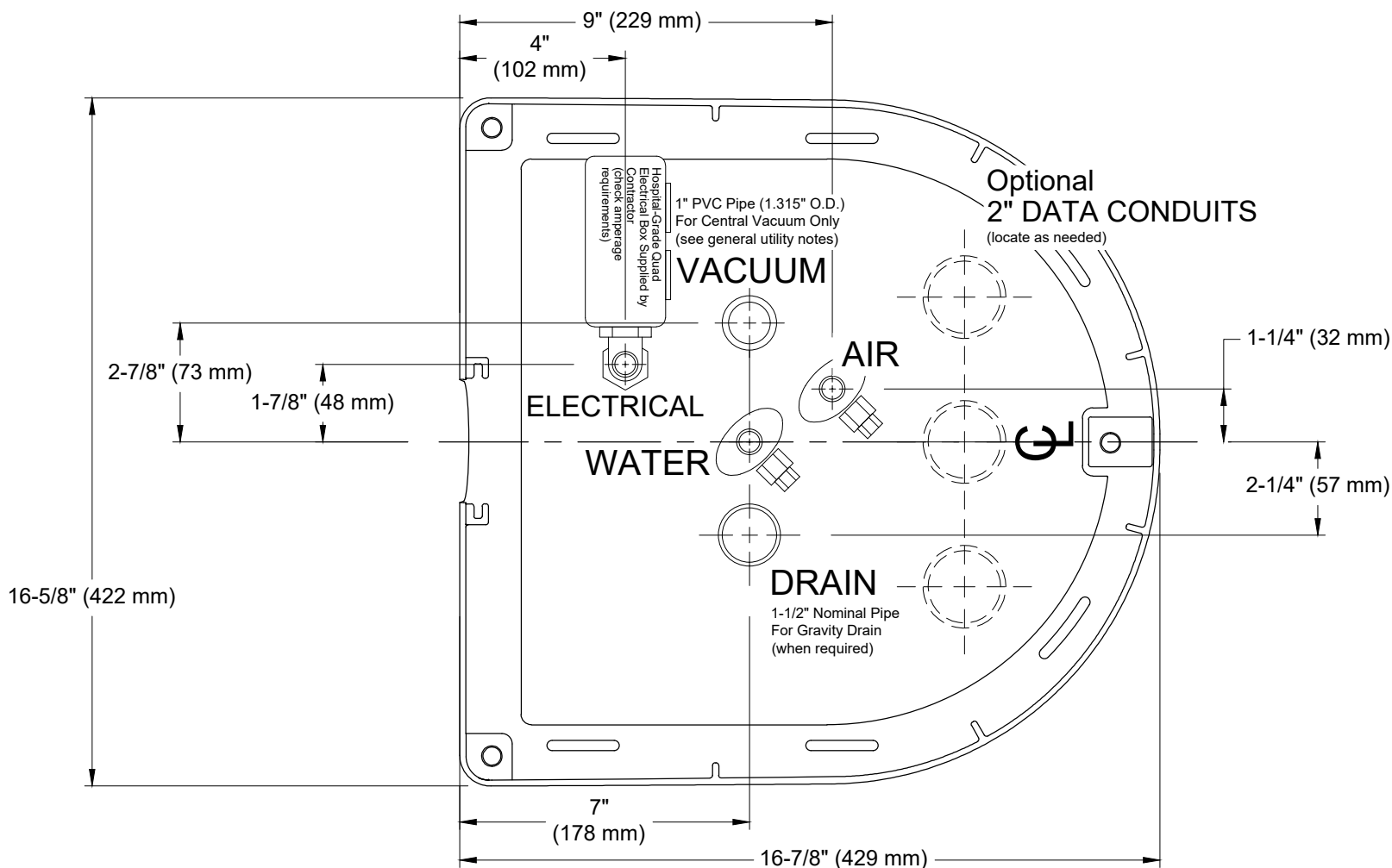

PLEASE NOTE: **This drawing is for reference purposes ONLY. It is NOT TO SCALE.**

## A-dec Floor Boxes Mini Template

Page 1 of 7

Copyright 2021 A-dec Inc.  
All rights reserved.

85.0472.02 Rev F



**A-dec Headquarters**

2601 Crestview Drive Newberg, Oregon 97132 USA

Tel: 1.800.547.1883 Within USA /Canada

Fax: 1.503.538.0276 Within USA /Canada

Tel: 1.503.538.7478 Outside USA /Canada

[www.a-dec.com](http://www.a-dec.com)

### DISCLAIMER NOTICE:

A-dec Inc. makes no warranty of any kind with regard to the content in this document, including, but not limited to, the implied warranties of merchantability and fitness for a particular purpose.

The customer must consult with planning and inspection authorities for compliance with local, state, federal codes and Americans with Disabilities Act.

The customer assumes all responsibility in assembling and using this document.

# A-dec 411, 311 (Version B) Floor Box

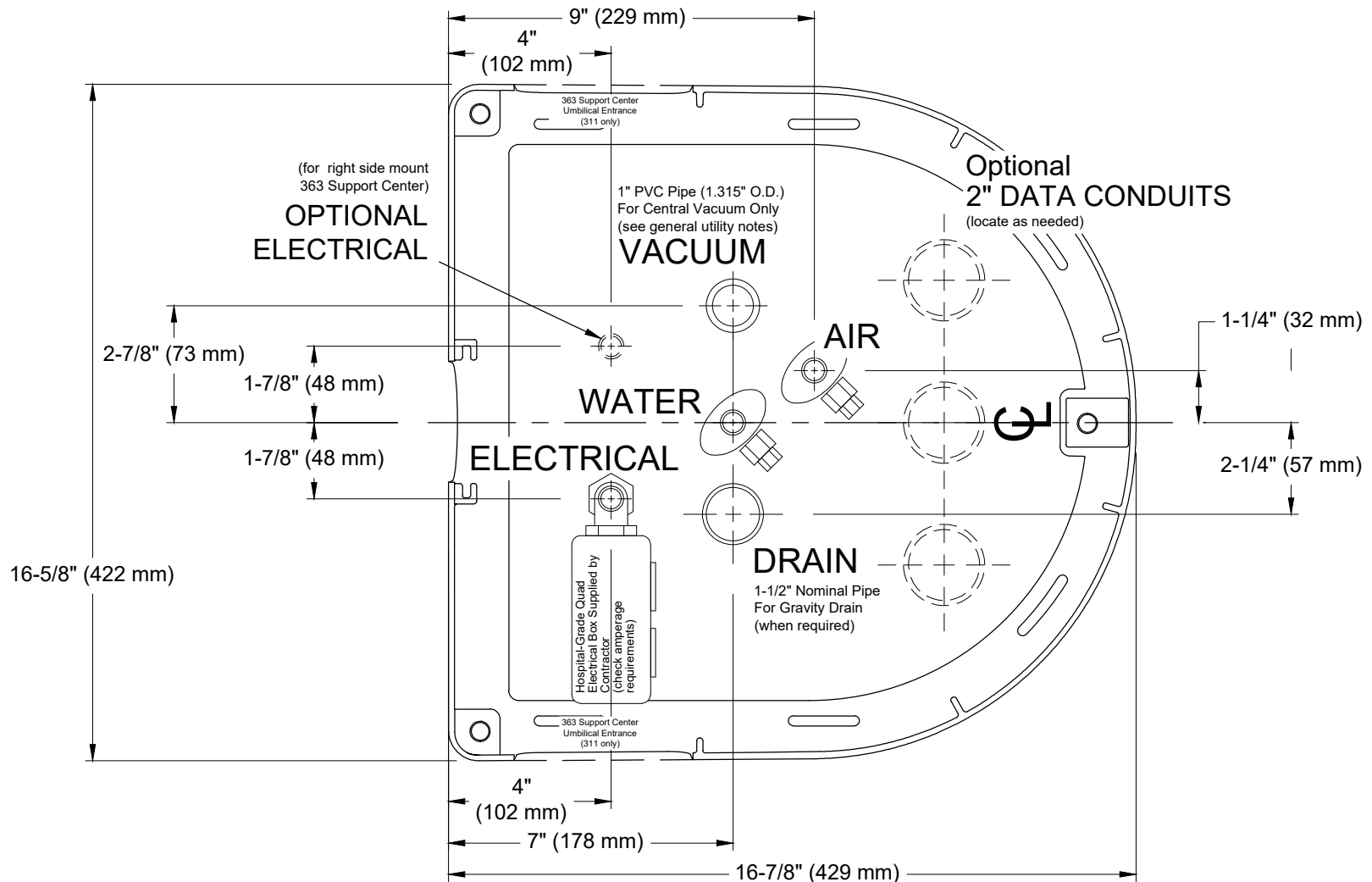

PLEASE NOTE: **This drawing is for reference purposes ONLY. It is NOT TO SCALE.**

## A-dec Floor Boxes Mini Template

Page 2 of 7

Copyright 2021 A-dec Inc.  
All rights reserved.

85.0472.02 Rev F



**A-dec Headquarters**

2601 Crestview Drive Newberg, Oregon 97132 USA

Tel: 1.800.547.1883 Within USA /Canada

Fax: 1.503.538.0276 Within USA /Canada

Tel: 1.503.538.7478 Outside USA /Canada

www.a-dec.com

### DISCLAIMER NOTICE:

A-dec Inc. makes no warranty of any kind with regard to the content in this document, including, but not limited to, the implied warranties of merchantability and fitness for a particular purpose.

The customer must consult with planning and inspection authorities for compliance with local, state, federal codes and Americans with Disabilities Act.

The customer assumes all responsibility in assembling and using this document.

# Large Stainless Steel Floor Box

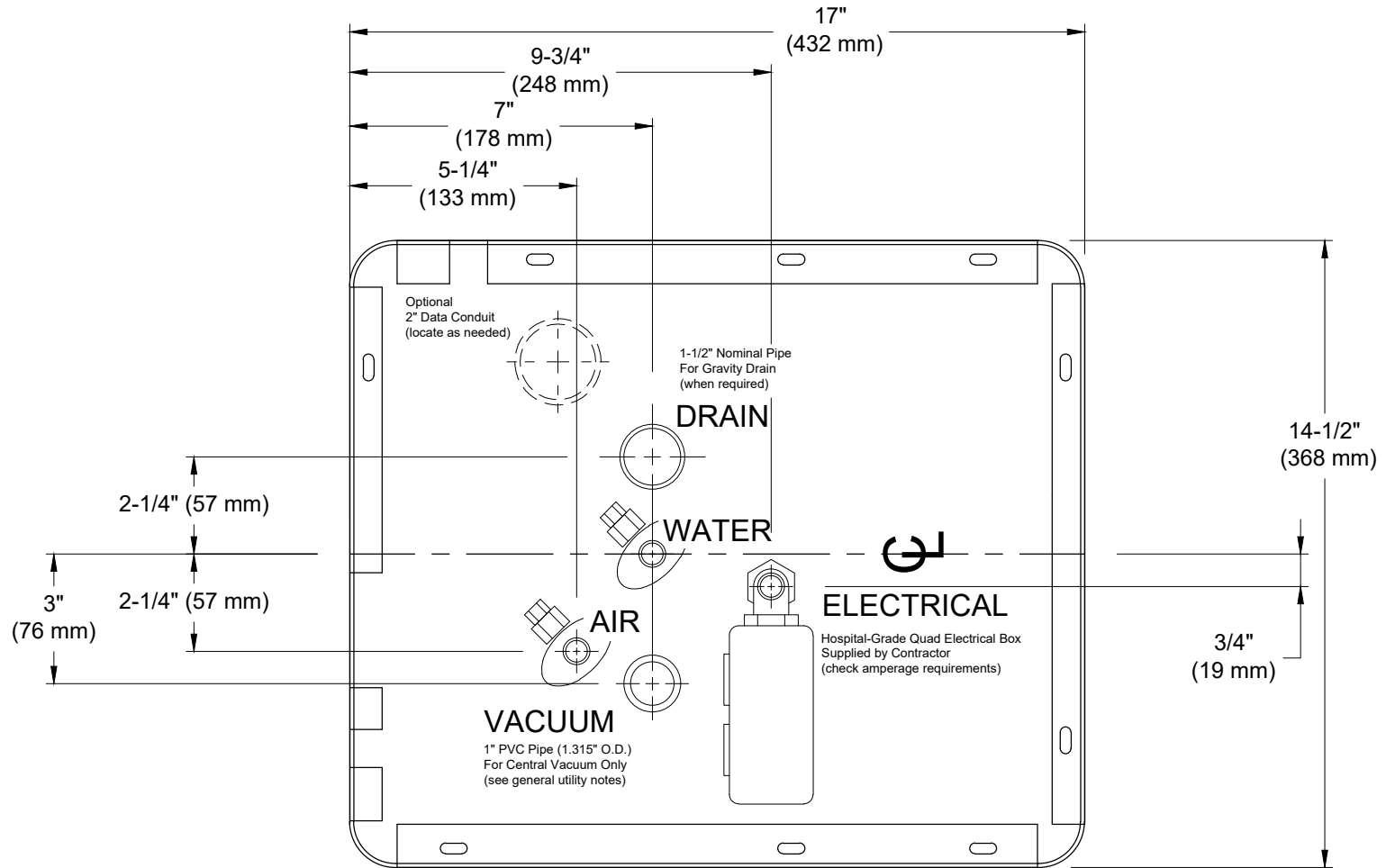

PLEASE NOTE: **This drawing is for reference purposes ONLY. It is NOT TO SCALE.**

## A-dec Floor Boxes Mini Template

Page 3 of 7

Copyright 2021 A-dec Inc.  
All rights reserved.

85.0472.02 Rev F



**A-dec Headquarters**

2601 Crestview Drive Newberg, Oregon 97132 USA

Tel: 1.800.547.1883 Within USA /Canada

Fax: 1.503.538.0276 Within USA /Canada

Tel: 1.503.538.7478 Outside USA /Canada

[www.a-dec.com](http://www.a-dec.com)

### DISCLAIMER NOTICE:

A-dec Inc. makes no warranty of any kind with regard to the content in this document, including, but not limited to, the implied warranties of merchantability and fitness for a particular purpose.

The customer must consult with planning and inspection authorities for compliance with local, state, federal codes and Americans with Disabilities Act.

The customer assumes all responsibility in assembling and using this document.

# Medium Stainless Steel Floor Box

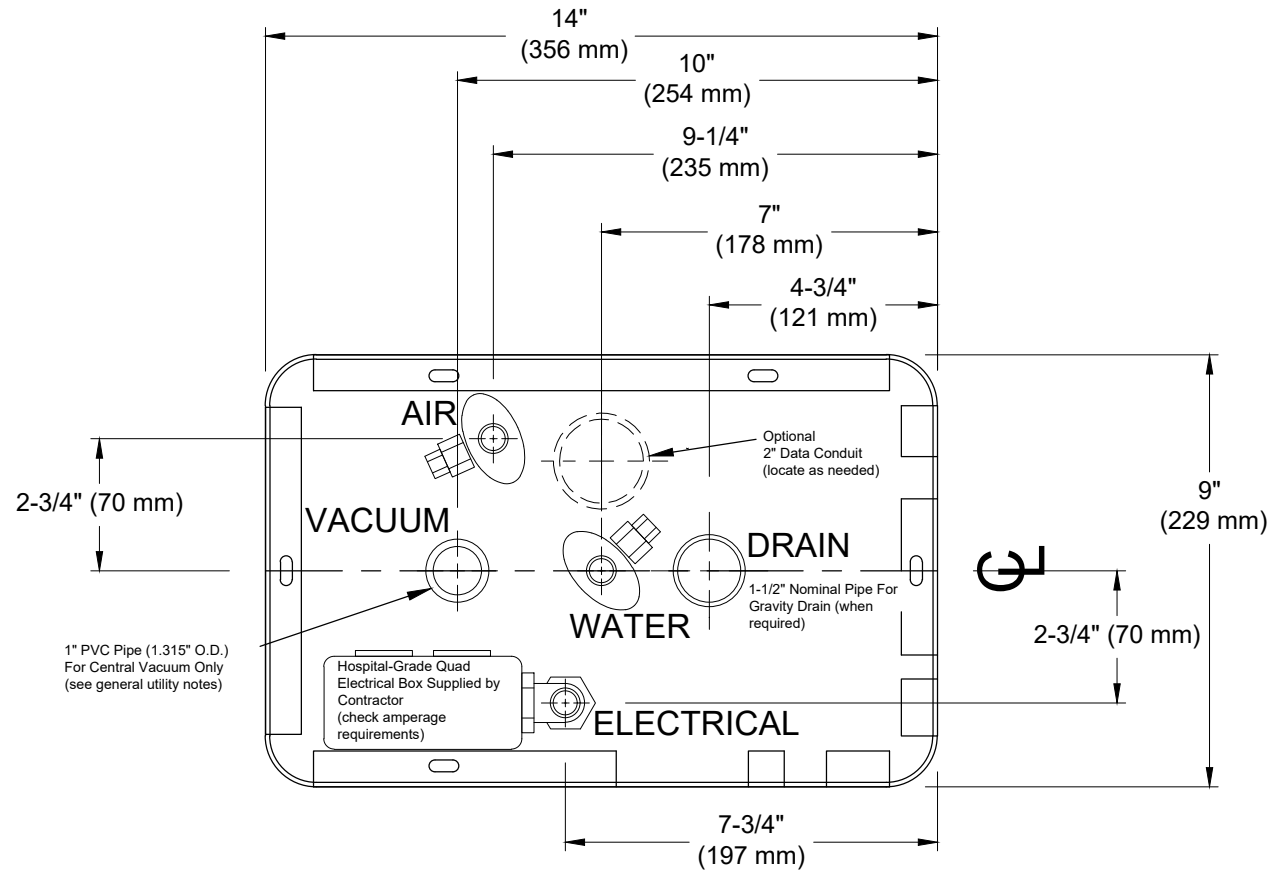

PLEASE NOTE: **This drawing is for reference purposes ONLY. It is NOT TO SCALE.**

## A-dec Floor Boxes Mini Template

Page 4 of 7

Copyright 2021 A-dec Inc.  
All rights reserved.

85.0472.02 Rev F



**A-dec Headquarters**

2601 Crestview Drive Newberg, Oregon 97132 USA

Tel: 1.800.547.1883 Within USA /Canada

Fax: 1.503.538.0276 Within USA /Canada

Tel: 1.503.538.7478 Outside USA /Canada

[www.a-dec.com](http://www.a-dec.com)

### DISCLAIMER NOTICE:

A-dec Inc. makes no warranty of any kind with regard to the content in this document, including, but not limited to, the implied warranties of merchantability and fitness for a particular purpose.

The customer must consult with planning and inspection authorities for compliance with local, state, federal codes and Americans with Disabilities Act.

The customer assumes all responsibility in assembling and using this document.

# A-dec 311 (Version A) Contoured Floor Box

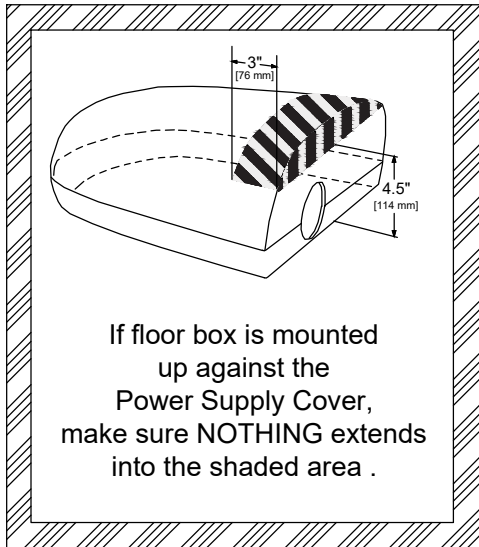
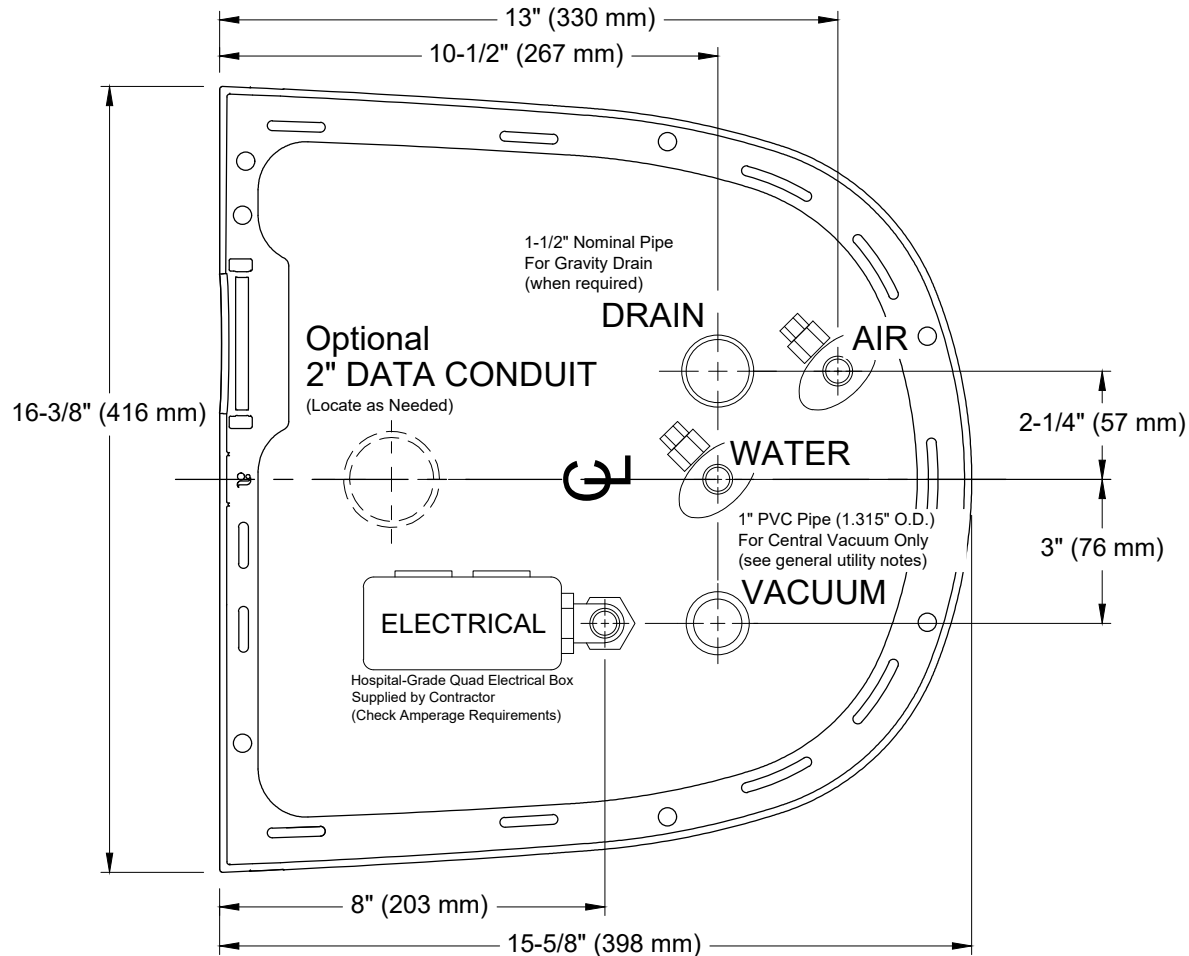

PLEASE NOTE: **This drawing is for reference purposes ONLY. It is NOT TO SCALE.**

## A-dec Floor Boxes Mini Template

Page 5 of 7

Copyright 2021 A-dec Inc.  
All rights reserved.

85.0472.02 Rev F



**A-dec Headquarters**

2601 Crestview Drive Newberg, Oregon 97132 USA

Tel: 1.800.547.1883 Within USA /Canada

Fax: 1.503.538.0276 Within USA /Canada

Tel: 1.503.538.7478 Outside USA /Canada

[www.a-dec.com](http://www.a-dec.com)

### DISCLAIMER NOTICE:

A-dec Inc. makes no warranty of any kind with regard to the content in this document, including, but not limited to, the implied warranties of merchantability and fitness for a particular purpose.

The customer must consult with planning and inspection authorities for compliance with local, state, federal codes and Americans with Disabilities Act.

The customer assumes all responsibility in assembling and using this document.

# A-dec 311 (Version A) Integrated Floor Box

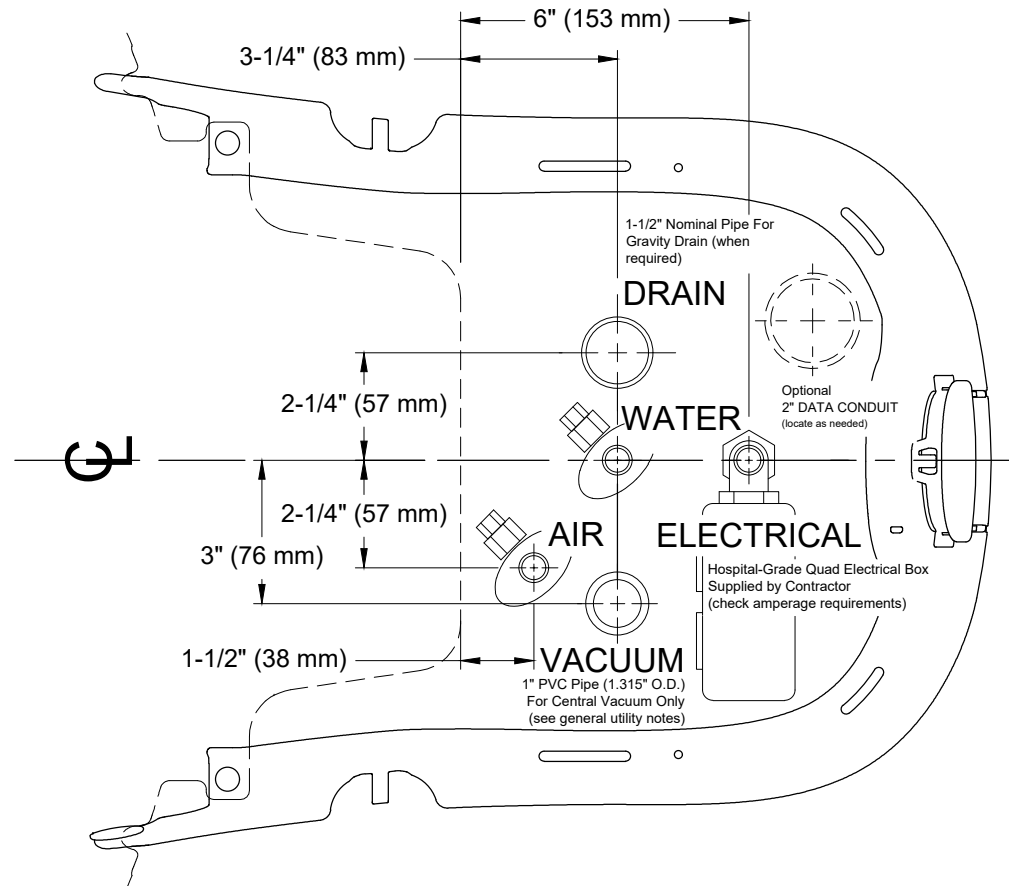

PLEASE NOTE: **This drawing is for reference purposes ONLY. It is NOT TO SCALE.**

## A-dec Floor Boxes Mini Template

Page 6 of 7

Copyright 2021 A-dec Inc.  
All rights reserved.

85.0472.02 Rev F



**A-dec Headquarters**

2601 Crestview Drive Newberg, Oregon 97132 USA

Tel: 1.800.547.1883 Within USA /Canada

Fax: 1.503.538.0276 Within USA /Canada

Tel: 1.503.538.7478 Outside USA /Canada

[www.a-dec.com](http://www.a-dec.com)

### DISCLAIMER NOTICE:

A-dec Inc. makes no warranty of any kind with regard to the content in this document, including, but not limited to, the implied warranties of merchantability and fitness for a particular purpose.

The customer must consult with planning and inspection authorities for compliance with local, state, federal codes and Americans with Disabilities Act.

The customer assumes all responsibility in assembling and using this document.

# Cascade Contoured Floor Box

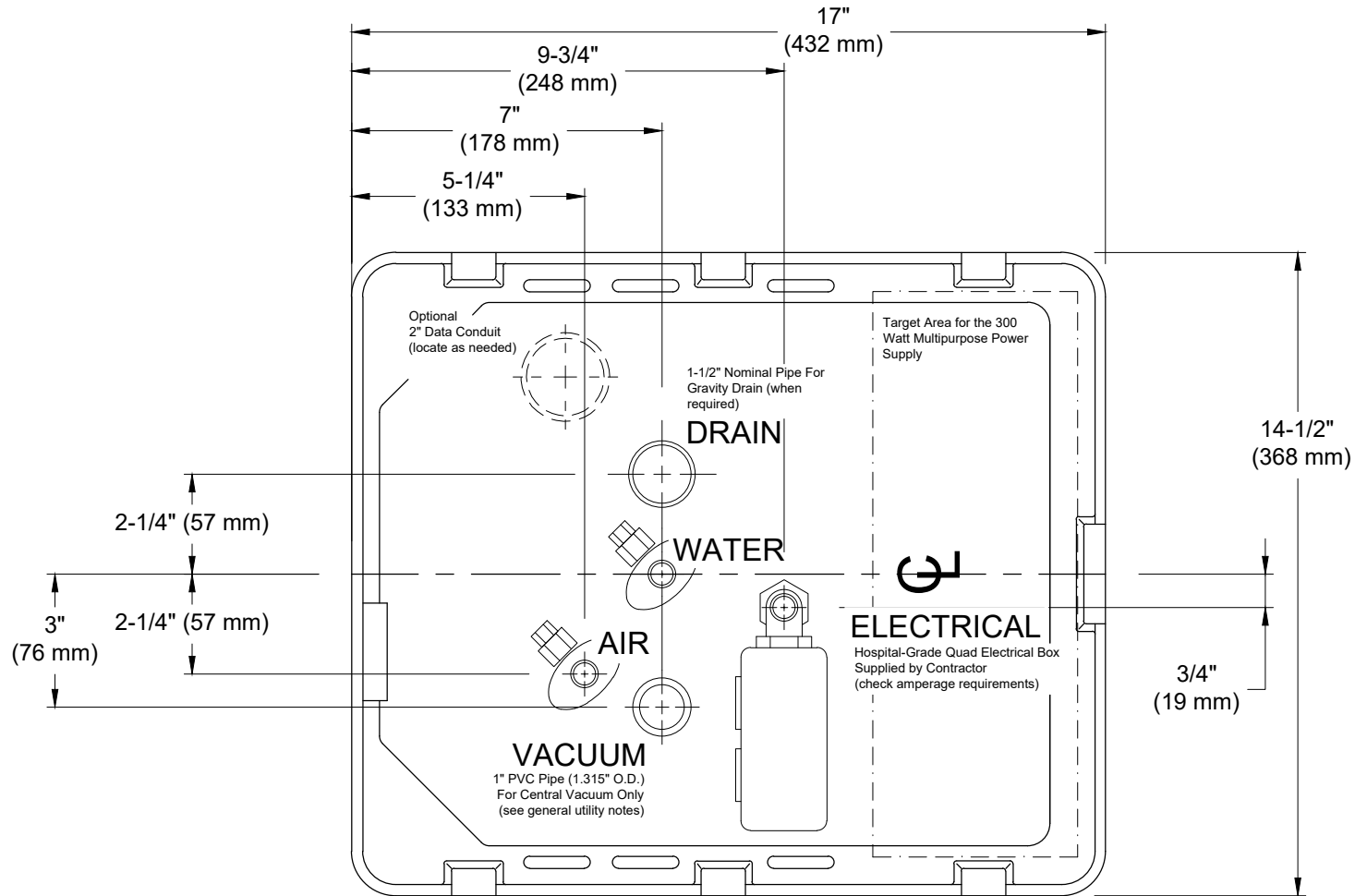

PLEASE NOTE: **This drawing is for reference purposes ONLY. It is NOT TO SCALE.**

## A-dec Floor Boxes Mini Template

Page 7 of 7

Copyright 2021 A-dec Inc.  
All rights reserved.

85.0472.02 Rev F



**A-dec Headquarters**

2601 Crestview Drive Newberg, Oregon 97132 USA

Tel: 1.800.547.1883 Within USA /Canada

Fax: 1.503.538.0276 Within USA /Canada

Tel: 1.503.538.7478 Outside USA /Canada

www.a-dec.com

### DISCLAIMER NOTICE:

A-dec Inc. makes no warranty of any kind with regard to the content in this document, including, but not limited to, the implied warranties of merchantability and fitness for a particular purpose.

The customer must consult with planning and inspection authorities for compliance with local, state, federal codes and Americans with Disabilities Act.

The customer assumes all responsibility in assembling and using this document.